

# ALL-IN-ONE MICRO ESS

HYX-MS3000



Carefully read this user manual before using the product.  
Read and save these instructions.



© ZHEJIANG HYXI TECHNOLOGY CO., LTD. All rights reserved.

This document cannot be copied fully or partially, transferred, or distributed in any form without the prior written permission of ZHEJIANG HYXI TECHNOLOGY CO., LTD (hereinafter referred to as "HYXI").

## TRADEMARKS



and other HYXI trademarks are the trademarks or registered trademarks of HYXI All other trademarks mentioned herein are the properties of their respective owners.

# Contents

<b>Preface</b> .....	<b>1</b>
Overview .....	1
Scope of Application .....	1
For Readers .....	1
Use of the Manual .....	1
Use of Symbols .....	2
<b>1 Product Overview</b> .....	<b>3</b>
1.1 Safety Instructions .....	3
1.2 Symbols on the Label .....	5
1.3 Radio Wave Interference Statement .....	5
<b>2 Inspection &amp; Unpacking</b> .....	<b>6</b>
2.1 Inspection .....	6
2.2 Packing List of All-in-one Micro ESS .....	6
2.3 Packing List of Battery Pack (Optional) .....	6
2.4 Packing List of Smart Meter (Optional) .....	7
2.5 Packing List of P1 Meter (Optional) .....	8
<b>3 Product Overview</b> .....	<b>10</b>
3.1 Product Introduction .....	10
3.2 Model Description .....	10
3.3 Product Dimensions .....	10
3.4 Product Appearance .....	11
3.5 Explanation for RGB LED Ring .....	12
<b>4 Installation</b> .....	<b>13</b>
4.1 Installation Site .....	13
4.1.1 Environment Requirements .....	13
4.1.2 Stacking Requirements .....	14
4.2 Installation Tools Requirement .....	15
<b>5 Mechanical Installation</b> .....	<b>16</b>
<b>6 Electrical Connection</b> .....	<b>21</b>
6.1 Grounding Connection .....	21
6.2 Grid Connection .....	22
6.3 Off Grid Connection .....	23
6.4 PV Connection .....	24
<b>7 System Commissioning</b> .....	<b>26</b>
7.1 Power-On / Off .....	26

7.2 Network Status Confirmation .....	26
<b>8 Human-Computer Interaction .....</b>	<b>27</b>
8.1 Installing the App.....	27
8.2 APP Configuration .....	27
<b>9 Alarm Description .....</b>	<b>28</b>
<b>10 Appendix.....</b>	<b>31</b>
10.1 Technical Parameter.....	31
10.2 Contact Information .....	33

# Preface

This manual describes HYXI All-in-one Micro ESS in terms of unpacking, product overview, installation, electrical connections, button and light explanation, customer service, and safety Instructions.

One All-in-one Micro ESS (HYX-MS3000) can support up to 5 Battery Pack (HYX-MS3000B).

All-in-one Micro ESS can be used with Smart Meter and some third-party devices, which is updated periodically.

## Overview

To ensure the proper installation and use of the product and its superior performance, before installation and operation of the product, please read the operating instructions in detail and follow all safety precautions in the instructions.

## Scope of Application

This manual is intended for the following device:

- HYX-MS3000
- HYX-MS3000B

## For Readers

This manual is intended for professional technicians who need to install, operate and maintain the product and for users who need to check the product parameters.

All installation operations must be carried out by professional technicians and only by professional technicians.

## Use of the Manual

Please read the manual carefully before using the product, the content of the manual will be updated and corrected, but it is inevitable that there is a slight discrepancy or error with the actual product. Users should refer to the actual product purchased and obtain the latest version of the manual by downloading from [www.hyxipower.com](http://www.hyxipower.com) or through sales channels.

The latest version of the manual is available for download at or through sales channels.

## Use of Symbols

To ensure user safety and property protection during product use, relevant information is provided and highlighted with the following symbols.

### **DANGER**

- Indicates a high potential hazard that, if not avoided, could result in death or serious injury.

### **CAUTION**

- Indicates a low potential hazard which, if not avoided, could result in moderate or minor injury.

### **NOTICE**

- Indicates a potential risk which, if not avoided, could result in the equipment not functioning properly or in property damage.

# 1 Product Overview

HYXI All-in-one Micro ESS (HYX-MS3000) is a hybrid ac-coupled energy storage system, offering different working modes. It can be charged from the grid and can also integrate PV generation via DC input. The system supplies reliable power to both the grid and household loads. They are designed and tested in strict accordance with relevant national safety standards.

For safety, all operations including transportation, storage, installation, usage and maintenance must comply with applicable laws, regulations, standards and specifications. Incorrect operation or use will endanger:

- Life and personal safety of operators or third parties.
- Other property of the operators or third parties.

## Important Safeguards and Warnings

This manual contains important instructions when installing and maintaining the All-in-one Micro ESS. You should read this manual thoroughly before installing or debugging it.

For safety, the technicians responsible for the installation, operation and maintenance of the All-in-one Micro ESS must have corresponding qualifications, received relevant training and master relevant skills. Installation, operation and maintenance must strictly follow the instructions contained in this manual.

## 1.1 Safety Instructions

### Pre-installation power safety:

- Before beginning any installation or cable work, always de-energize and verify the equipment is completely powered off.
- When the equipment is energized, never install or remove cables.

### Personnel & operational qualifications:

- Only qualified professionals or personnel with manufacturer-approved training may install, operate, or maintain this equipment. If the equipment is used in a manner not specified by the manufacturer, the protection provided by the equipment may be impaired.
- Use dedicated insulated tools for all work to prevent electric shock and short circuits.

### Personal protective measures:

- Before starting work, remove all conductive personal items (e.g., rings, necklaces, watches).
- If there is any risk of contact with wet or damp objects, do not operate the equipment.

### Equipment inspection & environment:

- Before installation, verify the equipment is undamaged. Do not power on until correct installation is confirmed by a qualified professional.
- Install the equipment in a dry, well-ventilated area, clear of liquids and flammable or explosive materials.
- Ensure ventilation openings and heat dissipation paths remain unobstructed at all times.

**Hazard prevention & emergency response:**

- Working on live equipment can cause severe electric shock, explosion, or fire, resulting in serious injury, death, or property damage.
- Non-standard operations can increase the risk of fire and electric shock.
- Stop work immediately and report any situation that poses a risk of personal injury or equipment damage.
- Do not touch energized equipment, as surfaces may be hot.

**Grounding & electrical connection safety:**

- For equipment requiring grounding, always connect the grounding cables first during installation and remove them last during disconnection.
- Before performing any installation or removal, ensure all power cables and their associated switches are disconnected.
- Do not damage or misuse grounding cables.
- Equipment terminals are only for electrical connections and must be installed in compliance with all local electrical codes and standards.

**Grid connection & repair compliance:**

- Before operating the system in on-grid mode, obtain approval from the local utility company.
- Any repairs must be conducted using qualified, compliant parts, installed only by an authorized contractor or service representative of HYXiPOWER Co., Limited. Components must be used only for their intended, certified purposes.















**Battery:**

- Servicing of batteries should be performed or supervised by personnel knowledgeable about batteries and the required precautions.
- When replacing batteries, replace with the same type and number of batteries or battery packs.

**General instructions regarding removal and installation of batteries.**

- CAUTION: Do not dispose of batteries in a fire. The batteries may explode.
- CAUTION: Do not open or damage batteries. Released electrolyte is harmful to the skin and eyes. It may be toxic.
- CAUTION: A battery can present a risk of electrical shock and high short-circuit current. The following precautions should be observed when working on batteries:
  - » a) Remove watches, rings, or other metal objects.
  - » b) Use tools with insulated handles.
  - » c) Wear rubber gloves and boots.
  - » d) Do not lay tools or metal parts on top of batteries.
  - » e) Disconnect charging source prior to connecting or disconnecting battery terminals.
  - » f) Determine if battery is inadvertently grounded. If inadvertently grounded, remove source from ground. Contact with any part of a grounded battery can result in electrical shock. The likelihood of such shock can be reduced if such grounds are removed during installation and maintenance (applicable to equipment and remote battery supplies not having a grounded supply circuit).

## 1.2 Symbols on the Label

Symbol	Description
	Risk of danger! There are potential hazards when the equipment is in operation, please take precautions when operating the equipment.
	Beware of electric shock! High voltage exists when the equipment is in operation, so when operating the equipment, make sure the equipment is powered off.
	Keep away from open flames or sources of ignition.
	There is a fatal danger of high voltage ! Disconnect power for at least 30 minutes before servicing the inverter.
	Do not dispose of the product together with the household waste.
	Please use the equipment reasonably, extreme conditions of use, the equipment has the risk of explosion.
	Observe enclosed documentation.
	CE certification mark. The inverter complies with the regulations of CE.
	No Open Flames/Smoking: Open flames and smoking are prohibited around the equipment to avoid the risk of fire.
	Keep Away from Flammable/Combustible Liquids: The device must be kept away from flammable liquids (e.g., gasoline, diesel) to prevent combustion upon contact.
	Fire Safety Warning: Indicates fire risks associated with the device; strictly follow fire safety protocols (e.g., keep away from fire sources, regularly inspect heat dissipation)
	Recyclable/Professional Recycling: Dispose of the end-of-life device via professional recycling channels; do not discard it randomly (complies with environmental requirements for electronic/energy storage equipment)
	Do not touch the inverter housing while it is in operation.
	Do not dispose of the product together with the household waste.

## 1.3 Radio Wave Interference Statement

After testing, this All-in-one Micro ESS meets the requirements of CE and EMC and is free from electromagnetic interference. This product might cause electromagnetic interference if it is improperly installed.

## 2 Inspection & Unpacking

### 2.1 Inspection

The equipment has been completely tested and strictly inspected before leaving the factory, but it may still be damaged during transportation, please make a detailed inspection before signing the product.

- Check whether there is any damage to the packing box.
- Check if the goods are complete and in accordance with the packing list.
- Unpack and check if the equipment inside is intact.

If there is any damage or incomplete goods, please contact with the shipping company or directly with Zhejiang Hyxi Technology Co., Ltd.

Provide photos of the damage to facilitate the provision of services.

### 2.2 Packing List of All-in-one Micro ESS

**Model: HYX-MS3000**

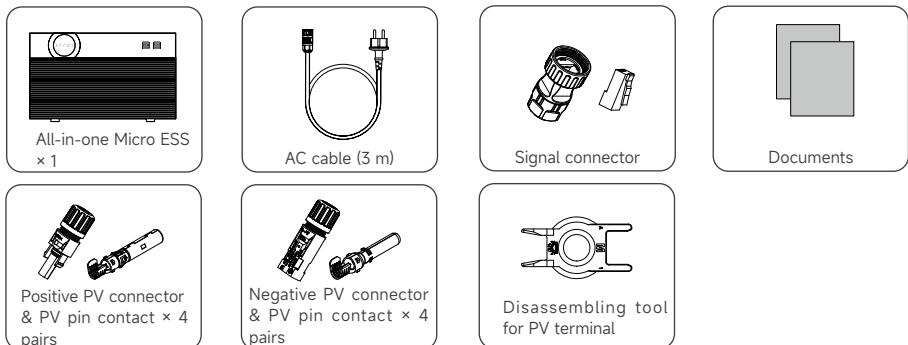

### 2.3 Packing List of Battery Pack (Optional)

**Model: HYX-MS3000B**

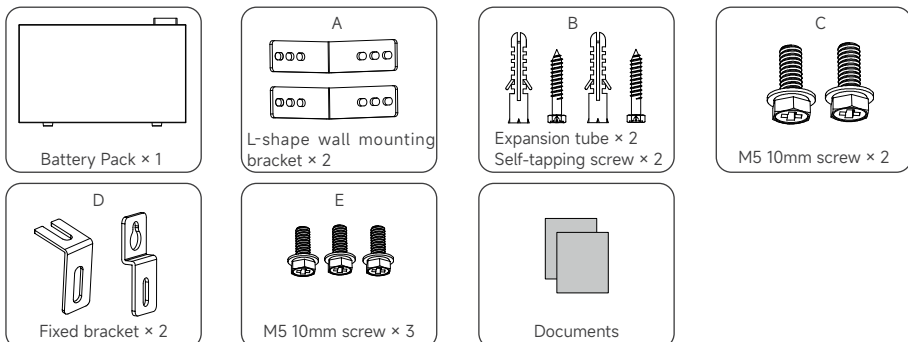

**NOTICE**

- Part A, B, and C are wall mounting kit. Part D and E are interlocking kit.

## 2.4 Packing List of Smart Meter (Optional)

### Single-phase smart meter

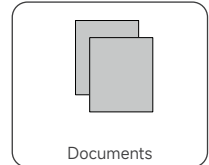
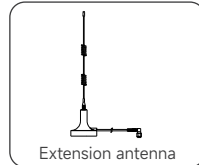
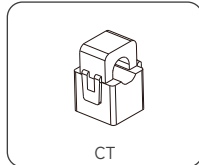
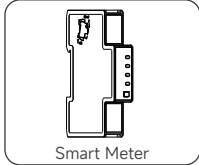

### Three-phase smart meter

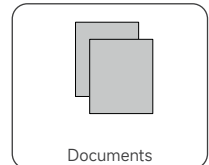
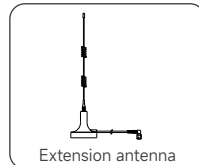
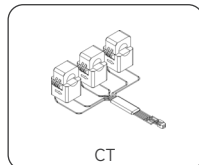
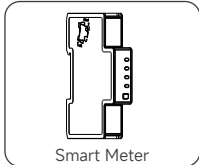
**NOTICE**

- The Smart Meter Series is a versatile energy metering solution designed for homes, office buildings, retail stores, manufacturing facilities, and other types of buildings. The smart meter supports DIN-rail installation inside the distribution box, making it especially suitable for new construction and electrical wiring projects.
- The smart meter series supports Wi-Fi for remote monitoring and control, and Bluetooth for device inclusion and configuration. As a energy meter, it can monitor and report key parameters such as accumulated energy, voltage, current, and power factor in real time.

**NOTICE**

- For detailed information about the installation, parameters, specifications, etc., of the meter, please refer to the instruction manual provided with the meter.

**NOTICE**

- Before installation, please be sure to read the safety instructions and installation guide carefully. Follow the instructions strictly to ensure all connections are firm and reliable. If you are not familiar with electrical installation, it is recommended to seek assistance from a professional electrician. They have the necessary knowledge and experience to ensure a safe and proper installation. Please note that incorrect installation may cause equipment damage, electrical faults, or even personal injury.

## 2.5 Packing List of P1 Meter (Optional)

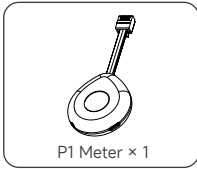

### NOTICE

- For detailed information about the installation, parameters, specifications, etc., of the meter, please refer to the instruction manual provided with the meter.

### NOTICE

- Installation and operation of the device can only be performed by qualified personnel. Only people that are authorized to install, connect and use this device, who have the proper knowledge about labeling and grounding electrical equipment and circuits and can do so in accordance with local (safety) regulations, are considered qualified personnel in this document.

## Device Compatibility

Item	Description
Supported Meter Protocols	<ul style="list-style-type: none"> <li>The P1 meter is compatible with most smart meters that use the DSMR 5.0 or 4.0 protocols. These protocol versions are usually displayed on your smart meter.</li> <li>We are continuously working to expand the list of compatible devices. Our primary focus is supporting DSMR 5.0 models to ensure optimal performance.</li> </ul>
Optimal Performance with DSMR 5.0	The P1 meter has been tested with selected DSMR 5.0 meters from leading Dutch brands. For best results and real-time energy management, we recommend using a DSMR 5.0 meter. The P1 meter is powered directly by a DSMR 5.0 smart meter when they are connected.
Limitations with DSMR 4.0	<ul style="list-style-type: none"> <li>Although DSMR 4.0 smart meters are generally compatible with the P1 meter for basic data reading, the data update frequency is limited to once every 10 seconds due to the DSMR 4.0 protocol. This limitation can affect the real-time responsiveness and effectiveness of the Energy Management System (EMS).</li> <li>When connecting the P1 meter to a DSMR 4.0 smart meter, external power is required. The P1 meter must be powered through an adapter plugged into a nearby wall outlet. Ensure that a wall outlet is available near the electrical panel.</li> </ul>

Recommended Actions for DSMR 4.0 Users	<p>If you have a DSMR 4.0 meter:</p> <ul style="list-style-type: none"><li>• Consider using Smart Meter for high-frequency data acquisition. This option requires wiring by a professional electrician.</li><li>• Alternatively, you can contact your grid operator to request a DSMR 5.0 meter upgrade. Availability and costs may vary depending on your operator and local regulations.</li></ul>
--	--

# 3 Product Overview

## 3.1 Product Introduction

All-in-one Micro ESS is a hybrid ac-coupled energy storage system, offering different working modes. It can be charged from the grid and can also integrate PV generation via DC input. The system supplies reliable power to both the grid and household loads. They are designed and tested in strict accordance with relevant national safety standards.

## 3.2 Model Description

This manual involves the following product models:

Product name	Product model
All-in-one Micro ESS	HYX-MS3000
Battery Pack	HYX-MS3000B

## HYX-MS 3000 /3000B

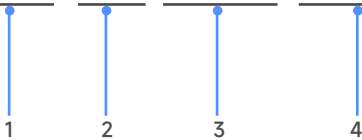

No.	Item	Description
1	Brand name	HYX: Zhejiang Hyxi Technology Co., Ltd.
2	Series name	MS: Micro Storage
3	Battery capacity	3000: 3000Wh
4	Product category	B: Battery Pack

## 3.3 Product Dimensions

HYX-MS3000: 460 (W) × 279 (H) × 281 (D) mm

HYX-MS3000B: 460 (W) × 296.5 (H) × 274 (D) mm

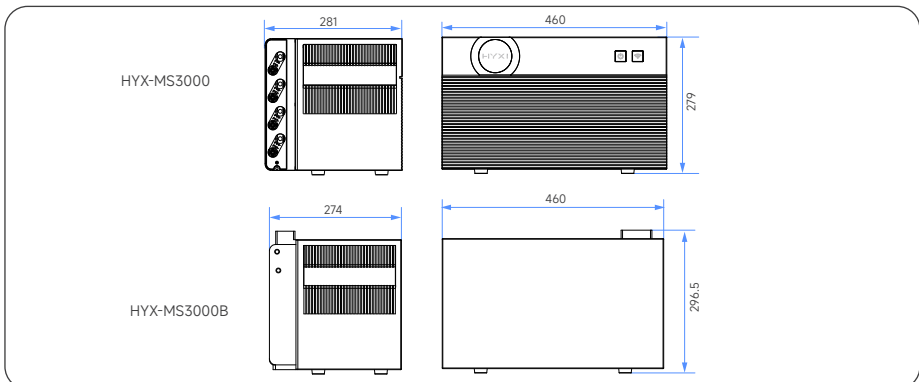



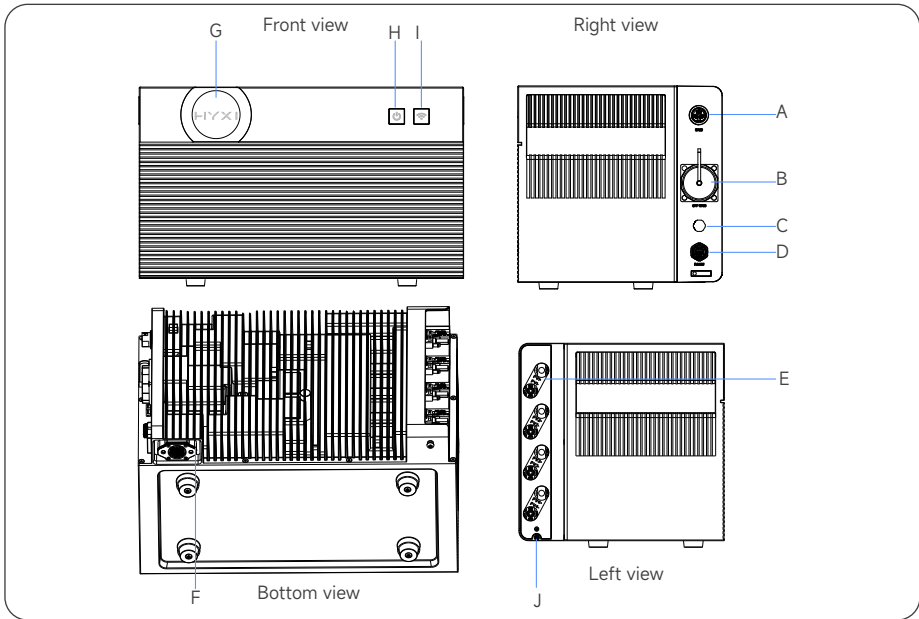

### 3.4 Product Appearance



No.	Item	Description
A	GRID Port	Output power to the grid and input energy from the grid
B	OFF GRID Port	For your essential appliances during a blackout
C	Vent Valve	/
D	RS485 Port	A standard network cable port used for thrid-party EMS to control your system
E	PV Port	Connecting PV module
F	Battery Expansion Port	To add more batteries
G	RGB LED Ring	Display the operating status of the device
H	Power Button	Turn on/off the system
I	IoT Button	Turn on/off the WiFi/BLE
J	Grounding Point	Connecting safety ground wire

### 3.5 Explanation for RGB LED Ring

Button	Action	Function
Power Button 	Press for 2 seconds	Turn the device on
	Press for 5 seconds	Turn the device off
	Press once (when the device is on)	Check the current battery level
IoT Button 	Press once	Enable internet connection
	Press for 2 seconds	Disable internet connection
	Press for 5 seconds	Reset bluetooth and Wi-Fi
Power Button IoT Button	Simultaneously press for 5 seconds	Reset the device

Button	Description	Status
Power Button 	Solid white	Normal operation
	Solid orange	Malfunction / warning
	Off	Powered off
IoT Button 	Solid white	Normal internet connection
	Flashing white	Internet connection enabled / reset
	Solid orange	Malfunction / warning
	Off	Internet connection disabled

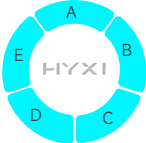
RGB Light	Description	Status
	The light breathes once from zone A to zone E.	Powered on
	The light breathes once from zone E to zone A.	Powered off
	The light illuminates toward zone E from the current zone, and then breathes again.	Charging
	The light fades toward zone A from the current zone, and then breathes again.	Discharging
	The light changes according to battery level.	Battery level
	The lights breathes from zone A to zone E.	Upgrading firmware

# 4 Installation





## 4.1 Installation Site

### 4.1.1 Environment Requirements

- Do not place the device near an area exposed to direct sunlight, fire, or explosive materials.
- Ensure the site is protected from potential hazards such as floods.
- The maximum operating altitude is 3,000 m.
- Preferred installation surfaces include solid brick-concrete structures, concrete walls, or floors.

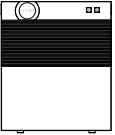
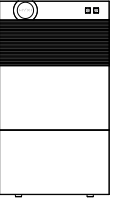
### 4.1.2 Stacking Requirements

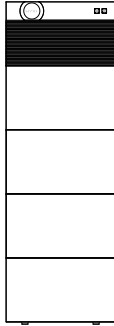
Select the appropriate installation space according to the equipment configuration to be installed. Reserve sufficient space for heat dissipation and safety isolation.

<p>All-in-one Micro ESS HYX- MS3000</p>						
<p>Model</p>	<p>HYX-MS 3000 / HYX- MS3000 -800</p>	<p>HYX-MS 3000-BP- 1 / HYX- MS3000- 800-BP-1</p>	<p>HYX-MS 3000-BP- 2 / HYX- MS3000- 800-BP-2</p>	<p>HYX-MS 3000-BP-3 / HYX-MS 3000-800- BP-3</p>	<p>HYX-MS 3000-BP- 4 / HYX- MS3000- 800-BP-4</p>	<p>HYX-MS 3000-BP- 5 / HYX- MS3000- 800-BP-5</p>
<p>Battery Pack</p>	<p>0</p>	<p>1</p>	<p>2</p>	<p>3</p>	<p>4</p>	<p>5</p>
<p>Energy</p>	<p>3014Wh</p>	<p>6028Wh</p>	<p>9042Wh</p>	<p>12056Wh</p>	<p>15070Wh</p>	<p>18084Wh</p>
<p>Rated Charging Power <b>(For 3000)*</b></p>	<p>1500W</p>	<p>1500W</p>	<p>1500W</p>	<p>1500W</p>	<p>1500W</p>	<p>1500W</p>
<p>Rated Charging Power <b>(For 3000- 800)*</b></p>	<p>800W</p>	<p>800W</p>	<p>800W</p>	<p>800W</p>	<p>800W</p>	<p>800W</p>
<p>Rated Discharging Power</p>	<p>1500W</p>	<p>1500W</p>	<p>1500W</p>	<p>1500W</p>	<p>1500W</p>	<p>1500W</p>

\*3000 here refers to model: HYX-MS3000 / HYX-MS3000-BP-1 / HYX-MS3000-BP-2 / HYX-MS3000-BP-3 / HYX-MS3000-BP-4 / HYX-MS3000-BP-5.

\*3000-800 here refers to model: HYX-MS3000-800 / HYX-MS3000-800-BP-1 / HYX-MS3000-800-BP-2 / HYX-MS3000-800-BP-3 / HYX-MS3000-800-BP-4 / HYX-MS3000-800-BP-5.

## 4.2 Installation Tools Requirement

Installation tools include, but are not limited to, the following recommended tools. And if necessary, other auxiliary tools can be used on site.

The following tools are not included in this package. Please make sure they are ready before installation and electrical connections.

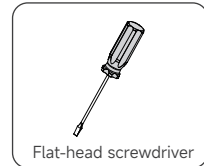
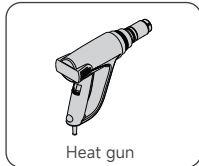
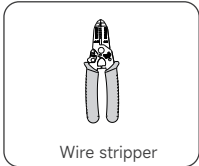
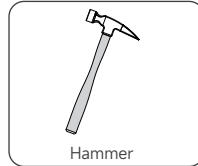
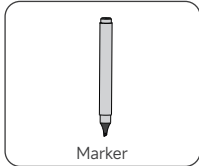

## 5 Mechanical Installation

### NOTICE

- When wiring, please ensure that the wire labels correspond to the markings on the enclosure.
- When stacking one or more units, wall fixation is required to prevent tipping. A maximum of five units can be stacked.
- Ensure the device is off during installation.
- The following steps describe how to install one All-in-one Micro ESS and two expansion battery packs as an example.

**Step 1:** Place the bottom expansion battery pack.

### NOTICE

- Ensure the heat sink on the back of the expansion battery pack faces the wall.
- Position the All-in-one Micro ESS within Wi-Fi coverage to connect to the network.
- Keep 20 to 50 mm away from the wall.

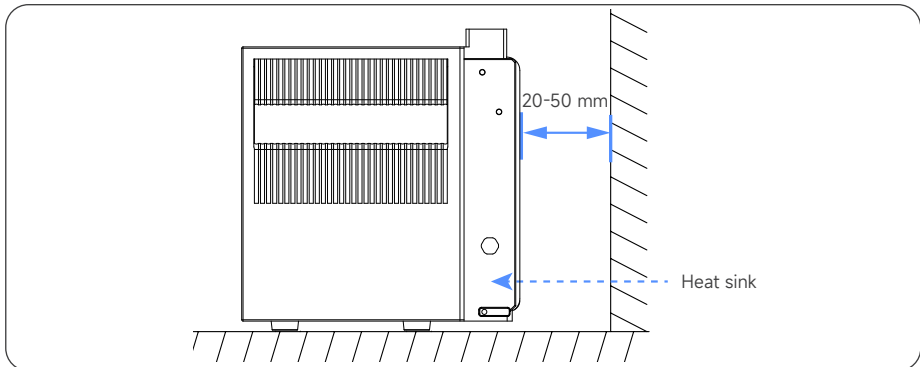

**Step 2:** Remove the protective plugs of the expansion battery packs.

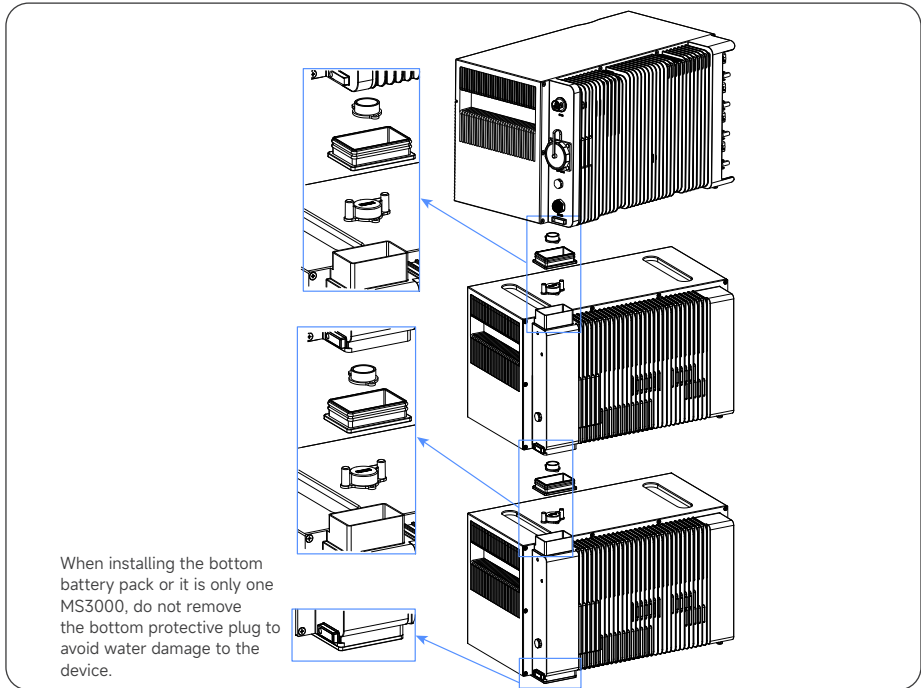

**Step 3:** Stack the All-in-one Micro ESS at the top: Stack expansion battery packs in sequence, then stack All-in-one Micro ESS at the top by inserting the following two ports into each other.

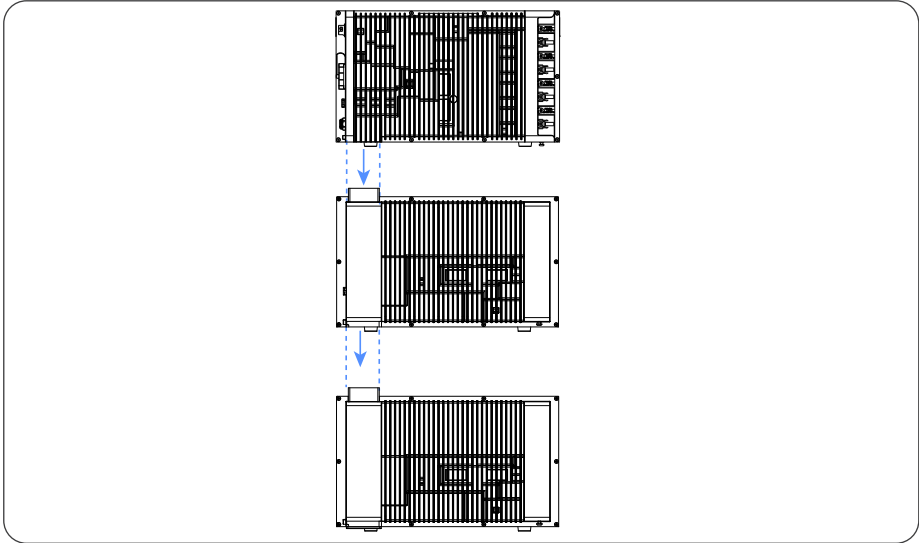

**Step 4:** Mount the system to the wall: Attach the L-shape wall mounting bracket to both sides of the first expansion battery pack.

- » 1. Install one side of the L-shape wall mounting bracket on the expansion battery pack, and pre-lock but not tighten the M5 10mm screw.
- » 2. Mark holes on the wall.
- » 3. Rotate the bracket down.
- » 4. Drill the marked holes.
- » 5. Insert the expansion tubes.
- » 6. Rotate the bracket back up.
- » 7. Tighten the self-tapping screws.
- » 8. Tighten the M5 10mm screws. (Torque: 2.0-2.5N.m)

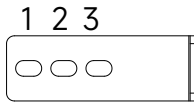

OB Hole Mounting Distance Range		
Position of the OB hole	Minimum distance from the wall	Maximum distance from the wall
1	46.5 mm	50.5 mm
2	33.0 mm	37.0 mm
3	19.5 mm	23.5 mm

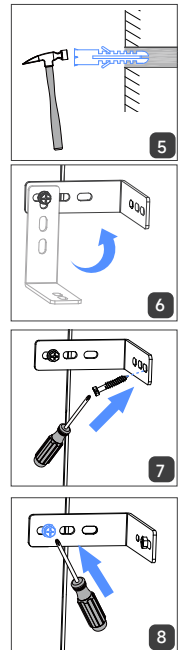
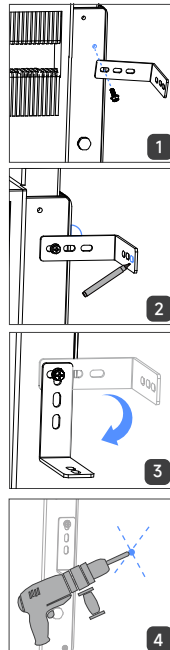
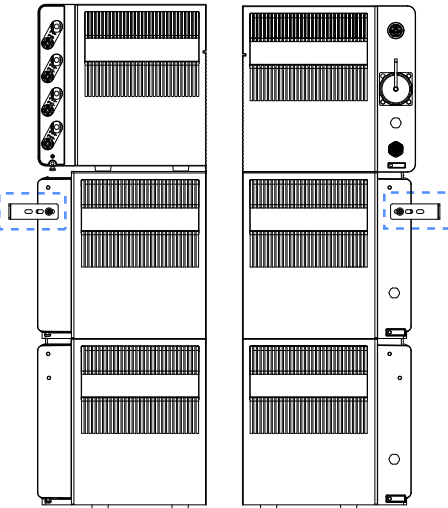

**Step 5:** Install the interlocking fixed bracket: Attach the fixed bracket to both sides of each expansion battery pack.

- » 1. Put the fixed bracket in place.
- » 2. Tighten the M5 10mm screws. (Torque: 2.0-2.5N.m)

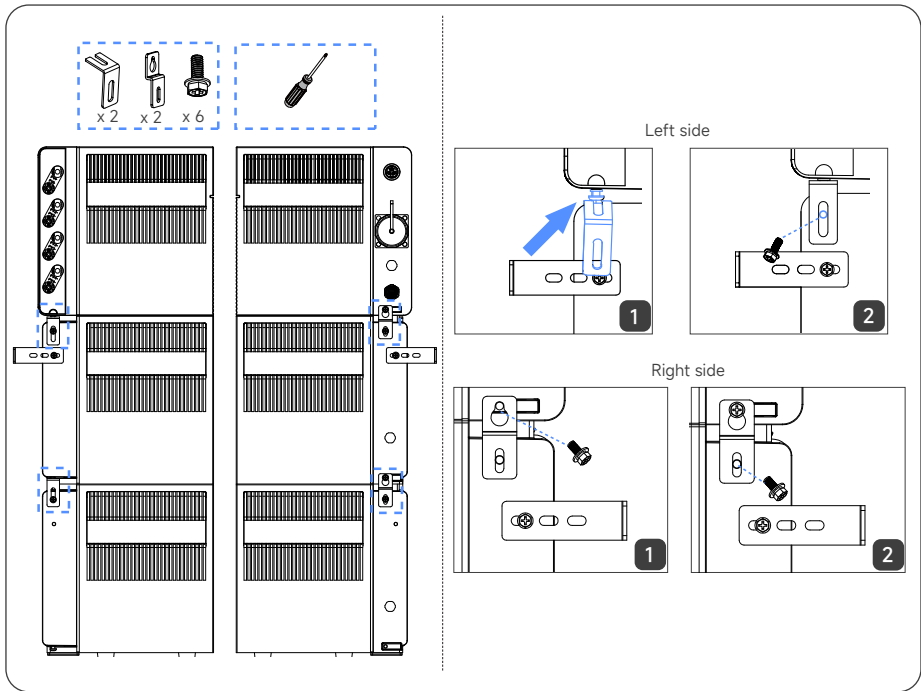

# 6 Electrical Connection

## 6.1 Grounding Connection

All-in-one Micro ESS must be connected to the external ground point, otherwise there is a risk of electric shock.

The following tools and supplies are not included in the package. Ensure that you have them ready before proceeding with the electrical connections.

Required supplies	Specifications
Grounding cable	2.5 mm <sup>2</sup> , yellow/green
OT terminal	Suitable for the 1 mm <sup>2</sup> Grounding cable and the M5 screw
Heat shrink tubing	Caliber: 8 mm Length: 25 mm
Heat gun	/
Phillips screwdriver	PH2

**Step 1:** Strip the insulation layer of the grounding cable.

**Step 2:** Insert the heat shrink tubing and OT terminal into the grounding cable.

**Step 3:** Use a crimping tool to crimp the OT terminal.

**Step 4:** Wrap the wire crimping area with the heat shrink tubing, then heat it with a heat gun.

**Step 5:** Loosen the pre-installed grounding screw and use it to secure the grounding cable.  
(Torque: 1.5±0.1N.m)

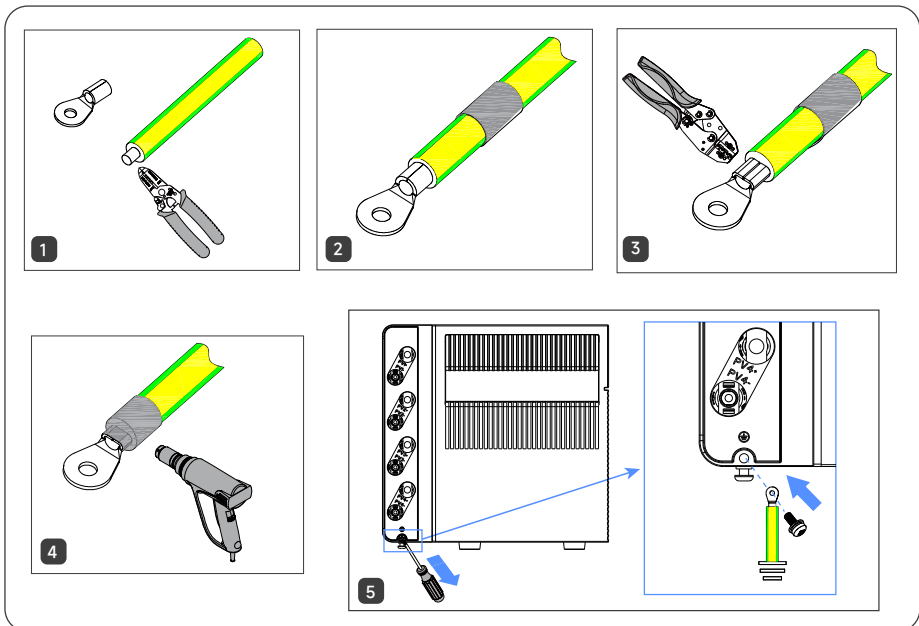

## 6.2 Grid Connection

Connect the grid terminal to the grid port.

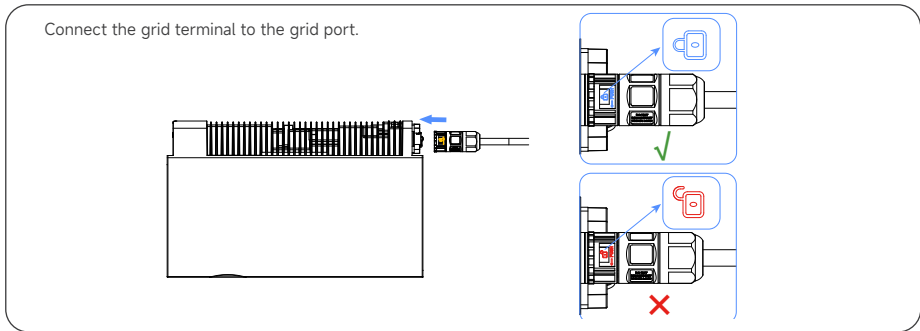

Connect All-in-one Micro ESS to a home outlet using the included AC cable (3 m).

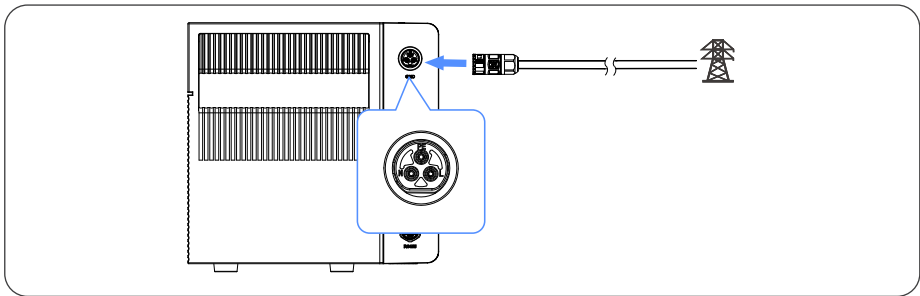

### Removing the grid terminal

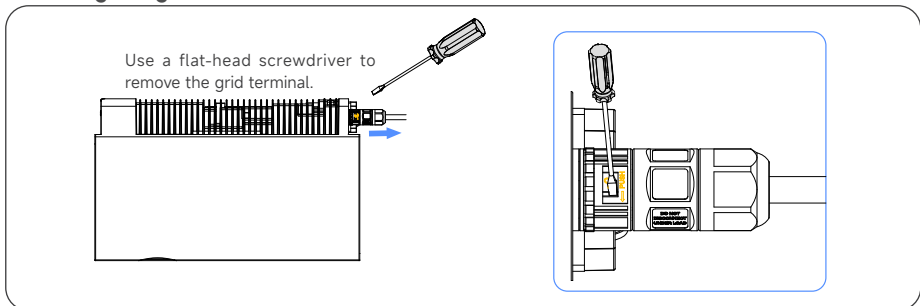

#### NOTICE

- Do not connect the device to the municipal power grid simultaneously for both grid connection and backup power. Doing so will result in a circuit break or damage to the device.
- The default nominal grid-connected output power is 800W. You can increase the grid-connected output power via the app. Enabling this function must comply with local regulations and can only be performed by authorized personnel !
- The included cables should be removed with tools.

### 6.3 Off Grid Connection

Power loads using the off grid port.

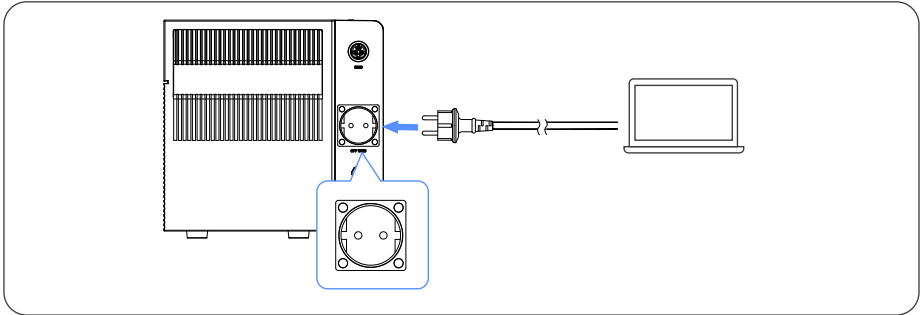

### 6.4 PV Connection

Ensure all unused PV ports on the all-in-one micro ESS are sealed with waterproof caps. Do not connect two or more PV modules in series, as this will result in an input voltage exceeding 60V and cause equipment damage.

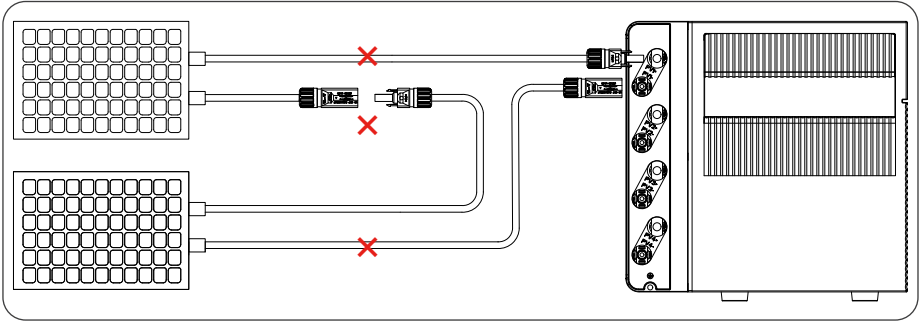

Do not connect the same PV connector set to multiple distinct PV input ports. For example, it is strictly prohibited to connect the positive terminal of PV Module 1 to the negative PV2 input port of the HYX-MS3000.

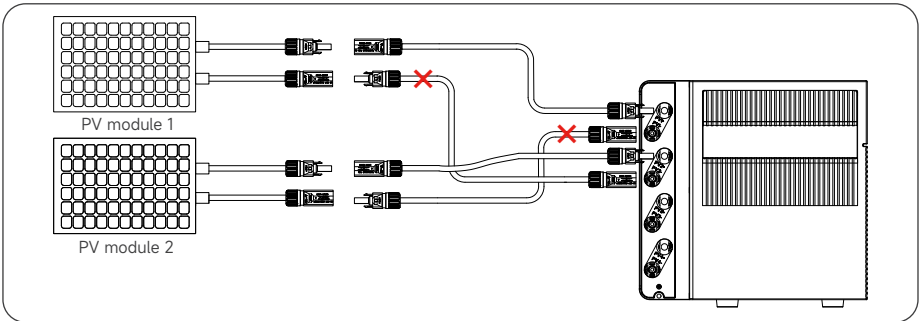

### PV Connection (Up to 4 PV Modules)

Connect each PV module directly to the same set of PV input ports.

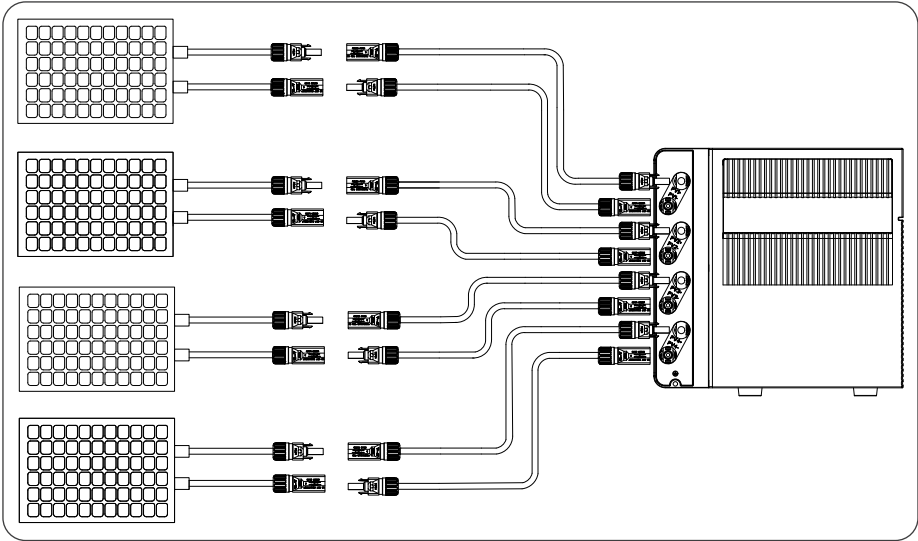

### Disconnecting PV connector

To disconnect the PV connectors, use the included disassembling tool for PV terminal.

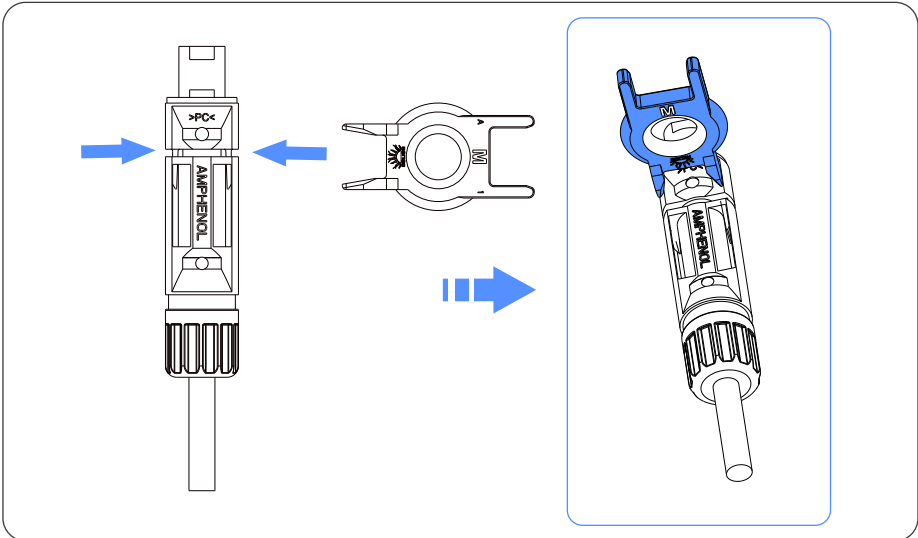

# 7 System Commissioning

## 7.1 Power-On / Off

- Press the power button for 2 seconds to turn All-in-one Micro ESS on.
- Press the power button for 5 seconds to turn All-in-one Micro ESS off.

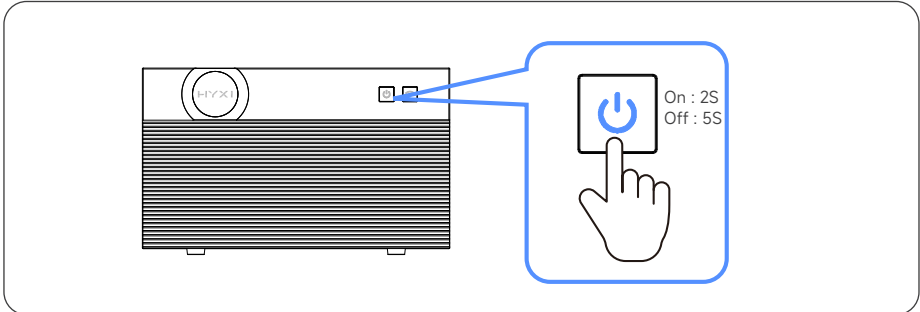

## 7.2 Network Status Confirmation

When the system is powered on, All-in-one Micro ESS will enter networking mode automatically. Confirm that the IoT button is flashing white. If the initial network connection is not completed within 60 minutes and there is no AC input available, it will automatically shut off.

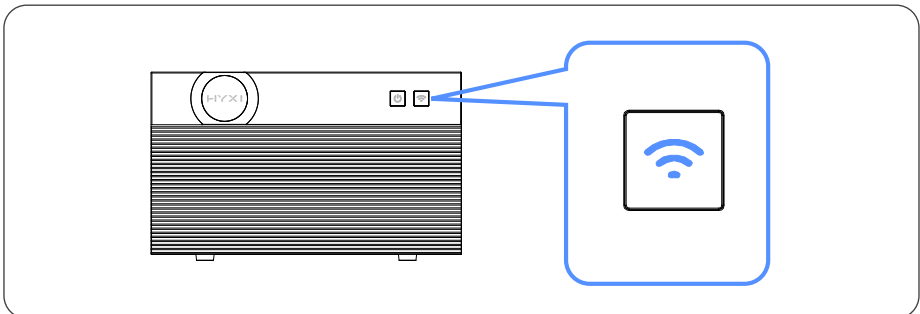

# 8 Human-Computer Interaction

## 8.1 Installing the App

### Method 1

Download and install the HYXI App through the following application stores:

- App Store (iOS)
- Google Play

### Method 2

Scan the following QR code to download and install the HYXI App according to the prompt information:



## 8.2 APP Configuration

For specification configuration, please scan the following QR code to check HYXI APP\_User Manual.



## 9 Alarm Description

Fault code	Fault description	Solutions
S0024	Hardware Protection	<p>Please restart or reset the device.</p> <ul style="list-style-type: none"> <li>If the issue recurs, it is recommended to restart the device up to 3 times, with a 10-minute interval between each attempt.</li> <li>If the alarm continues to occur, please contact your distributor or the device manufacturer.</li> </ul>
S0025	Software Protection	<p>Please restart or reset the device.</p> <ul style="list-style-type: none"> <li>If the issue recurs, it is recommended to restart the device up to 3 times, with a 10-minute interval between each attempt.</li> <li>If the alarm continues to occur, please contact your distributor or the device manufacturer.</li> </ul>
S0026	Temperature Protection	<ul style="list-style-type: none"> <li>Check whether the ambient temperature is within the allowable operating range. If the environment is normal, please restart or reset the device.</li> <li>If the issue recurs, it is recommended to restart the device up to 3 times, with a 10-minute interval between each attempt.</li> <li>If the alarm continues to occur, please contact your distributor or the device manufacturer.</li> </ul>
14020	Insulation Resistance Fault	<ul style="list-style-type: none"> <li>Check whether the DC and AC cable insulation is normal.</li> <li>If the insulation is normal but the fault continues to occur, please contact your distributor or the device manufacturer.</li> </ul>
14021	Leakage Current Fault	<ul style="list-style-type: none"> <li>Check whether the device installation environment is normal. Do not install the device in a humid environment.</li> <li>Check whether the DC and AC cable insulation is normal.</li> <li>If the insulation is normal but the fault continues to occur, please contact your distributor or the device manufacturer.</li> </ul>
14022	Grounding Fault	<ul style="list-style-type: none"> <li>Check whether the grounding is normal.</li> <li>If the grounding is normal but the fault continues to occur, please contact your distributor or the device manufacturer.</li> </ul>

Fault code	Fault description	Solutions
14023	Leakage Current Self-Test Fault	<ul style="list-style-type: none"> <li>• Check whether the device installation environment is normal. Do not install the device in a humid environment.</li> <li>• If the insulation is normal but the fault continues to occur, please contact your distributor or the device manufacturer</li> </ul>
S0002	Grid Overvoltage	<ul style="list-style-type: none"> <li>• If this occurs occasionally, it may be due to a short-term grid anomaly. The device will automatically resume normal operation once the grid stabilizes, and no manual intervention is required.</li> </ul>
S0003	Grid Undervoltage	<ul style="list-style-type: none"> <li>• If this occurs frequently, please check whether the grid voltage is within the allowable range.               <ul style="list-style-type: none"> <li>» If the grid voltage is abnormal, contact the local power utility.</li> <li>» After confirmation by the power utility, the overvoltage or undervoltage limits can be adjusted through the monitoring platform.</li> </ul> </li> </ul>
S0004	Grid Overfrequency	<ul style="list-style-type: none"> <li>• If this occurs occasionally, it may be due to a short-term grid anomaly. The device will automatically resume normal operation once the grid stabilizes, and no manual intervention is required.</li> <li>• If this occurs frequently, please check whether the grid voltage is within the allowable range:               <ul style="list-style-type: none"> <li>» If the grid voltage is abnormal, contact the local power utility.</li> <li>» After confirmation by the power utility, the overfrequency or underfrequency limits can be adjusted through the monitoring platform.</li> </ul> </li> </ul>
S0005	Grid Underfrequency	<ul style="list-style-type: none"> <li>• If this occurs occasionally, it may be due to a short-term grid anomaly. The device will automatically resume normal operation once the grid stabilizes, and no manual intervention is required.</li> <li>• If this occurs frequently, please check whether the grid voltage is within the allowable range:               <ul style="list-style-type: none"> <li>» If the grid voltage is abnormal, contact the local power utility.</li> <li>» After confirmation by the power utility, the overfrequency or underfrequency limits can be adjusted through the monitoring platform.</li> </ul> </li> </ul>

Fault code	Fault description	Solutions
S0027	Communication Error	<ul style="list-style-type: none"> <li>• Please contact your distributor or the device manufacturer.</li> </ul>
S0028	Battery Temperature Protection	<ul style="list-style-type: none"> <li>• Please contact your dealer or equipment supplier for alarm recovery.</li> </ul>
S0029	Battery Hardware Protection	<ul style="list-style-type: none"> <li>• Check whether all external connections are normal, such as whether the AC and DC cables have damaged insulation and whether the grounding is proper.</li> <li>• If the issue recurs, it is recommended to restart the device up to 3 times, with a 10-minute interval between each attempt.</li> <li>• If the alarm continues to occur, please contact your distributor or the device manufacturer.</li> </ul>
S0030	Battery Current Abnormal	<ul style="list-style-type: none"> <li>• Please contact your dealer or equipment supplier for alarm recovery.</li> </ul>
S0031	Battery Voltage Abnormal	<ul style="list-style-type: none"> <li>• Please contact your dealer or equipment supplier for alarm recovery.</li> </ul>
12868	SOC Jumping Fault	<ul style="list-style-type: none"> <li>• Please restart or reset the device.</li> <li>• If the issue recurs, it is recommended to restart the device up to 3 times, with a 10-minute interval between each attempt.</li> <li>• If the alarm continues to occur, please contact your distributor or the device manufacturer.</li> </ul>

# 10 Appendix

## 10.1 Technical Parameter

Product Model	HYX-MS3000
<b>DC Input</b>	
DC Input [W]	2400
Max. PV Input Voltage [V]	60
MPPT Voltage Range [V]	16 – 60
Start-up Voltage [V]	20
Max. PV Input Current [A]	4 × 18
Max. Input Short Circuit Current [A]	4 × 25
No. of MPP Trackers	4
<b>AC Output (On-grid terminal)</b>	
Nominal AC Output Power [W]	800
Max. AC Output Apparent Power [VA]	1500 *
Rated AC Output Voltage/Range [V]	220 or 230 or 240 / 183 ~ 276
Nominal AC Frequency/Range [Hz]	50/45 ~ 55 or 60/55 ~ 65
Rated AC Output Current [A]	3.64/3.48/3.34
Max. AC Output Current [A]	6.82/6.53/6.25
Power Factor Range	>0.99(Default)/0.8 Leading ~ 0.8 Lagging(Adjustable)
THDi (Rated Power) [%]	<3%
<b>AC Input (On-grid terminal)</b>	
Max. AC Input Power [W]	1500
Max. AC Input Current [A]	6.82/6.53/6.25
Rated AC Input Voltage/Range [V]	220 / 230 / 240, 183 ~ 276
Nominal AC Frequency/Range [Hz]	50/45 ~ 55 or 60/55 ~ 65
<b>AC Output (off-grid terminal)</b>	
Rated AC Output Power [W]	1500
Max. AC Output Current [A]	6.82/6.53/6.25
Max. AC Output Apparent Power (Bypass) [VA]	2300
Max. AC Output Current [A]	10.46/10.00/9.59
AC Nominal Output Voltage [V]/ Frequency [Hz]	220 / 230 / 240, 50/60
<b>Battery Data</b>	
Battery Chemistry	LiFePO4
Battery Nominal Voltage [V]	9.6
Battery Nominal Energy [Wh]	3014
Max. Charging Power [W]	1500
Max. Discharging Power [W]	1500
Battery Cycle Life	≥ 10000 (@25°C±2°C, 60%EOL)
<b>Other Technical Specification</b>	
Display	LED & APP
Ingress Protection Rating	IP66

Operating Ambient Temperature Range [°C]	-20 to +55*
Humidity [%]	5% ~ 95% (No Condensing)
Altitude [m]	3000
Dimension (W*H*D) [mm]	460*279*281
Weight [kg]	29
Cooling Concept	Natural Cooling
Communication	WiFi & Bluetooth
<b>Standard</b>	
Safety	IEC62109-1/-2
EMC	IEC62619, UN38.3, IEC/EN 61000-6-1, IEC/EN 61000-6-2, IEC/EN 61000-6-3, IEC/EN 61000-6-4
Grid Connection Standard	VDE4105, IEC61727/62116, VDE0126, AS4777.2, CEI 0 21, EN50549-1, G98, C10-11, UNE217002, NTS 2.1

\* 1500: Enabling this function must comply with local regulations and should only be performed by authorized personnel !

\* -20 to +55: Support -20° C startup and automatically self-heat the device for a certain time to the charge temperature range.

Product Model	HYX-MS3000B
<b>Battery Data</b>	
Battery Chemistry	LiFePO4
Battery Nominal Voltage [V]	9.6
Battery Nominal Energy [Wh]	3014
Max. Charging/Discharging Power [W]	1500/1500
Battery Operating Voltage [V]	6-10.95
Battery Cycle Life	≥ 10,000
Parallel Capability (pcs)	5
<b>General Data</b>	
Communication Interface	CAN
Dimension (W x D x H) [mm]	460*274*296.5
Weight [kg]	26
Operating Temperature Range [° C]	-20-55
Max. Operating Altitude [m]	3000
Relative Humidity	5% ~ 95% (No Condensing)
Certification	UN38.3, IEC62619, CE
Installation Style	Floor-Mounted

---

## 10.2 Contact Information

If you have any questions about this product, please contact us.

In order to provide you with faster and better after-sales service, we need your assistance in providing the following information.

- Equipment model : \_\_\_\_\_
- Serial number of the equipment: \_\_\_\_\_
- Fault code / name: \_\_\_\_\_
- A brief description of the fault phenomenon: \_\_\_\_\_  
\_\_\_\_\_  
\_\_\_\_\_  
\_\_\_\_\_

Version: UM\_HYX-MS3000\_V1.0-202606\_EN

The manual is subject to change without notice while the product is being improved.



**Zhejiang Hyxi Technology Co., Ltd.**

Address: Building 1, No. 57 Jiang'er Road, Changhe Street, Binjiang District,  
Hangzhou, Zhejiang Province, China

Website: [www.hyxipower.com](http://www.hyxipower.com)

E-mail: [support@hyxipower.com](mailto:support@hyxipower.com)