

STACKABLE ALL-IN-ONE ESS

HYX-H5.7K-HSPA、HYX-H7.6K-HSPA、
HYX-H11.5K-HSPA

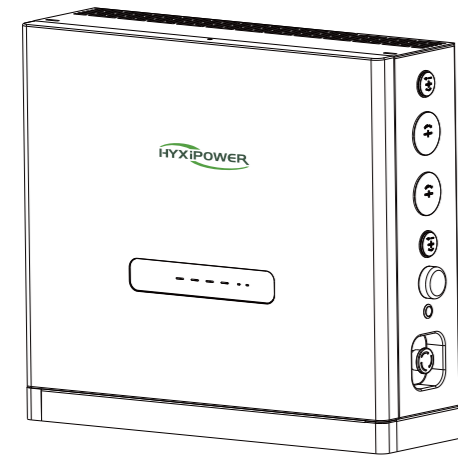

1 Packing list

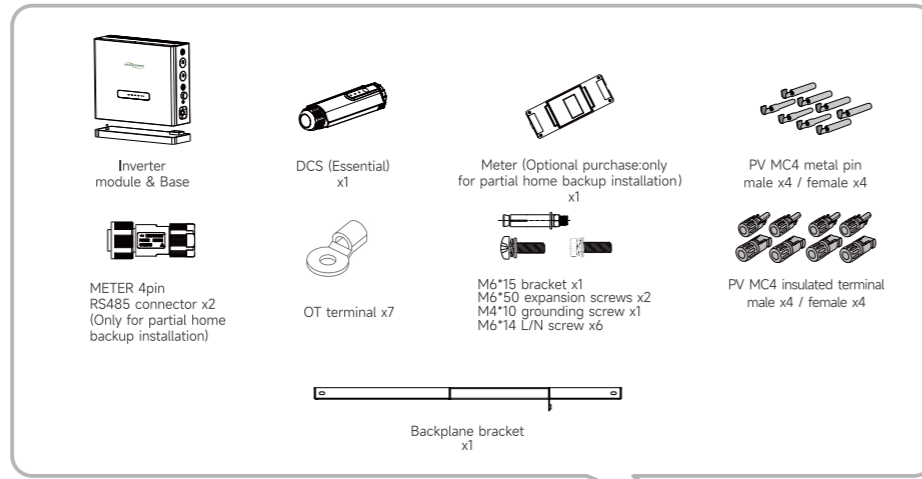

NOTES

Inverter Module and Base in the same package

2 Installation Preparation

Installation Environment Requirements

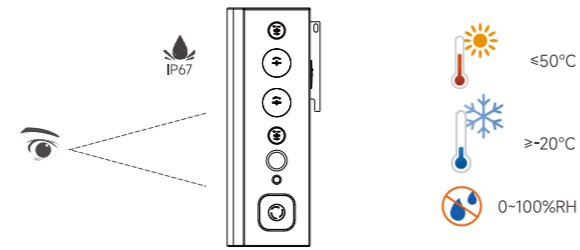

3 ALL-IN-ONE Installation

Backplane bracket installation

- Step 1: Insert the backplane bracket into the corresponding slot on the inverter module.
- Step 2: Secure the backplane bracket to the inverter module with M6 screws.

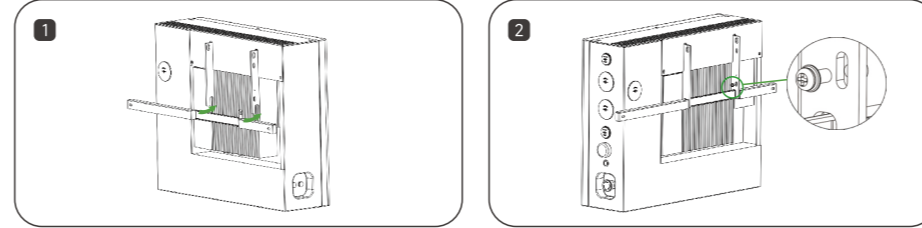
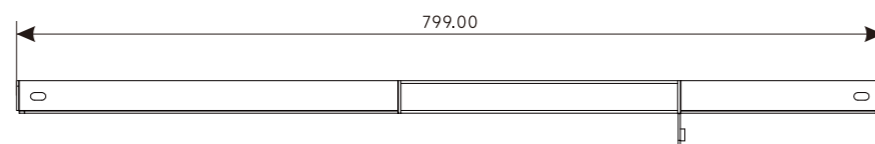

3.1 Please select one of the “hard-floor mounted” or “soft-floor mounted” Hard-floor mounted Installation Steps

- Step 1: Stacking the pack on the base.
- Step 2: Stacking the inverter module on the pack.
- Step 3: Mark the inverter bracket's two expansion screw holes on the wall, remove the inverter module to drive expansion screws into the wall.
- Step 4: Move back the inverter module, bolting the inverter to the wall with “M6 bracket expansion screws”. (No need to fix inverter module on structural beam. The backplane bracket is only to prevent tipping, it is not a stress point.)

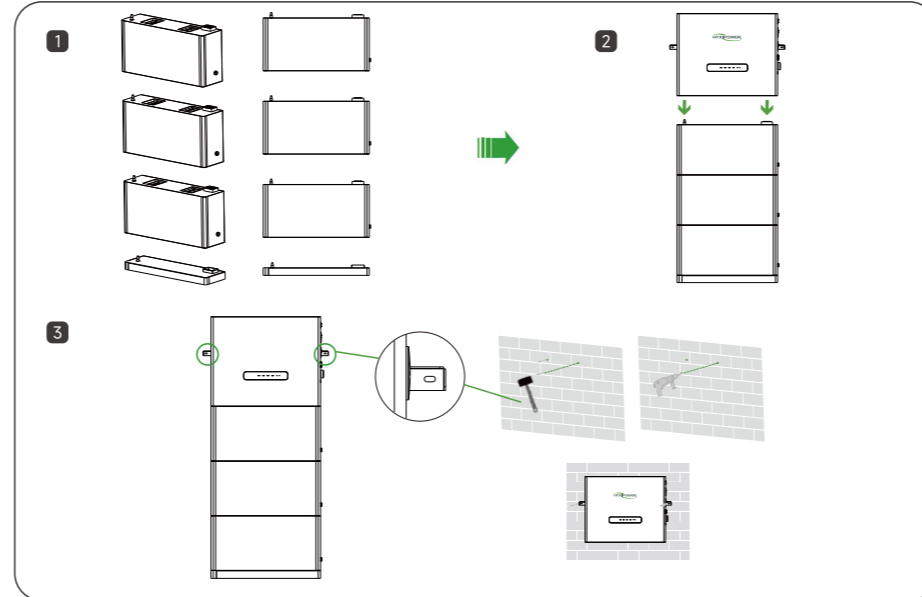

Soft-floor mounted Installation Steps

(Requires purchase of additional soft-floor mounted base)

Soft-floor mounted installation for soft ground, please make sure that the soft-floor mounted base is attached to the ground and supported by the floor, the soft-floor mounted base is only intended for soft surfaces such as grass or mud, but still needs to be supported by the floor.

- Step 1: Secure the soft-floor mounted base with “M12*70 expansion screws”. Please make sure that the expansion screws are driven into the load-bearing studs of the wall. Then place the base that comes standard in the all-in-one package on the soft-floor mounted base.
- Step 2: Stacking the pack on the base. Then stacking the inverter module on the pack.
- Step 3: Mark the inverter bracket's two expansion screw holes on the wall, remove the inverter module to drive expansion screws into the wall. Move back the inverter module, bolting the inverter to the wall with “M6 bracket expansion screws”. (No need to fix inverter module on structural beam. The backplane bracket is only to prevent tipping, it is not a stress point.)

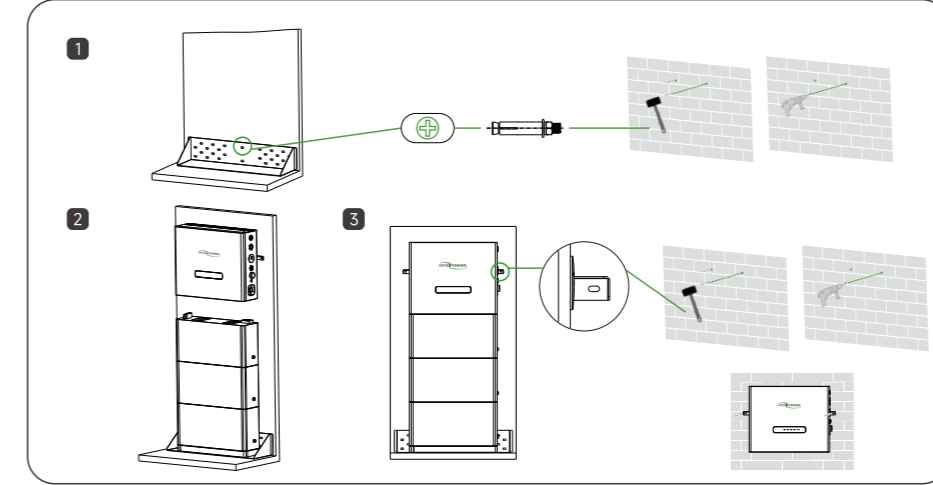

NOTES

The battery base (in inverter package) must be installed, otherwise the battery cannot form a circuit.

4 Electrical Connection

4.1 Electrical Connection Preparation

- Step 1: Remove the M3*8 screws from the top of the inverter module.
- Step 2: Lift the inverter module cover from the upper end.
- Step 3: Remove the 4xM6 screws from the wiring compartment cover.
- Step 4: Unscrew the top three protective casing except the COM port.

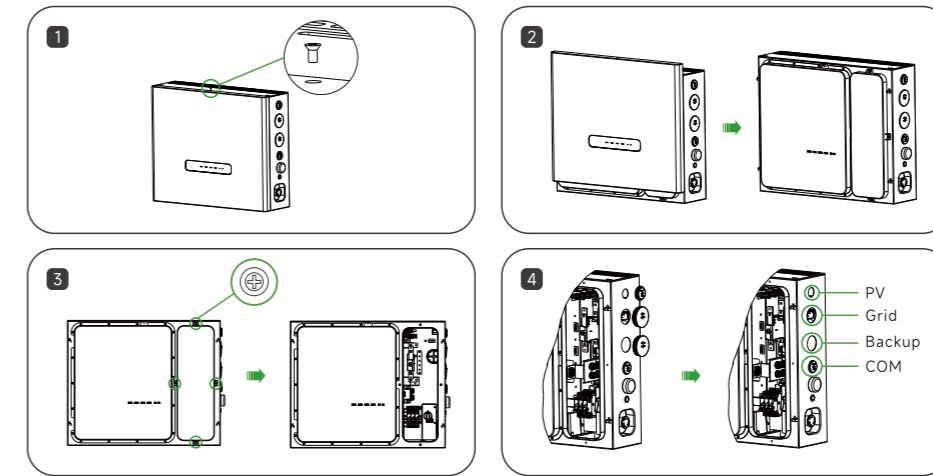

4.2 Grounding Procedure

The cross-sectional area of the secondary grounding cable must be the same as the cross-sectional area of the PE core in the AC cable.

The secondary grounding cable and terminal block are to be prepared by the customer.

- Step 1: Make the cable and crimp the terminal block.
- Step 2: Remove the screws from the grounding terminal and use a screwdriver to secure the cable.
- Step 3: Apply silicone or paint to the grounding terminal to improve its corrosion resistance.
- Step 4: Secure the grounding cable to the corresponding terminals with “M4*10 grounding screw”.
- Step 5: Thread the grounding cable through the corresponding position.

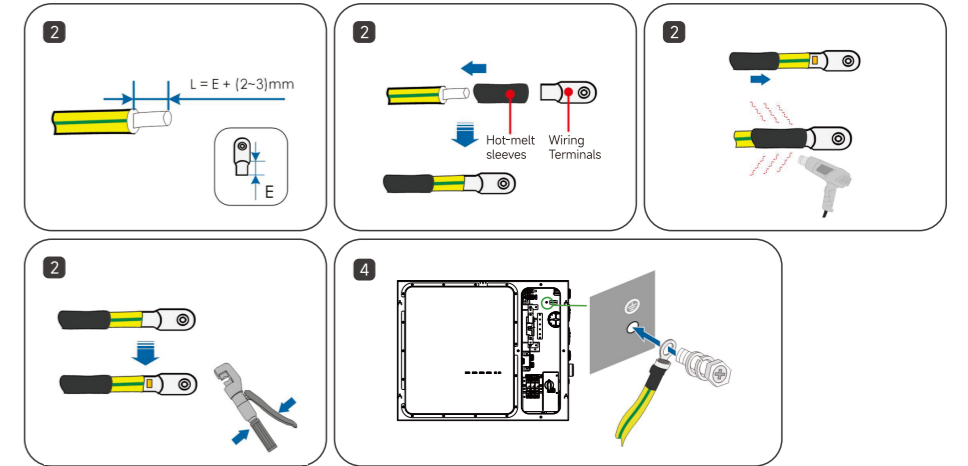

4.2 PV Side Connection

- Step 1: Strip off the insulation layer of all DC cables by about 7mm.
- Step 2: Use crimping pliers to bundle the cable ends at the wiring terminals.
- Step 3: Pass the cable through the cable gland, insert the insulating sleeve and fasten it. Gently pull the cable to ensure that it is connected and fastened. Use a force of 2.5-3N·m to tighten the gland and insulating sleeve.
- Step 4: Use a multi-meter to check and confirm that the polarity of the photovoltaic string connecting cable is correct.
- Step 5: Connect the PV connectors to the corresponding terminals until a click is heard.

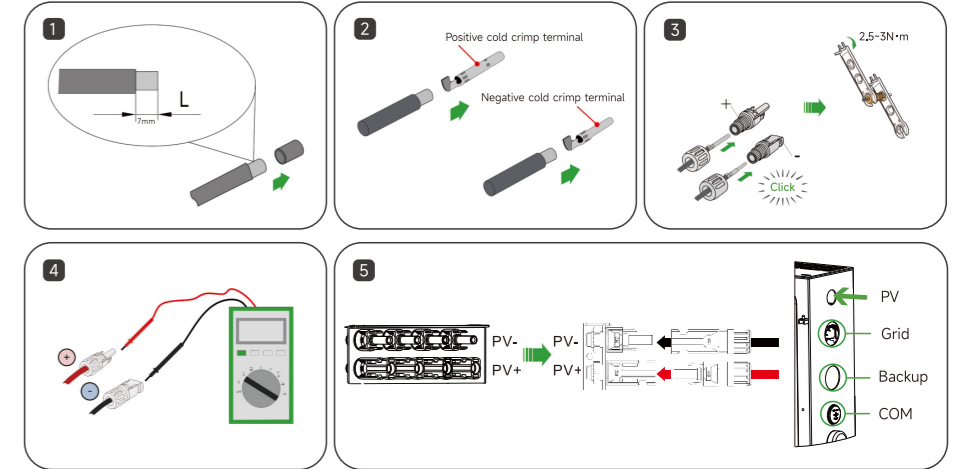

NOTES

PV2 and PV3 share one MPPT

4.3 Please select one of the following "4.3.1 Whole Home Backup" or "4.3.2 Partial Home Backup".

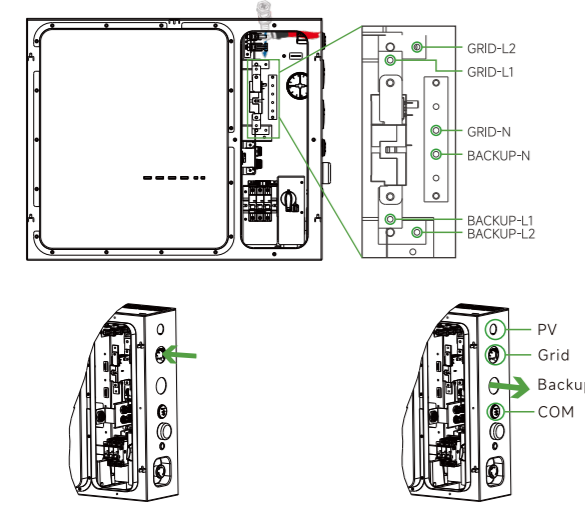

Terminal Layout

NOTES

Upper limit of current per phase: 200A

4.3.1 Whole Home Backup

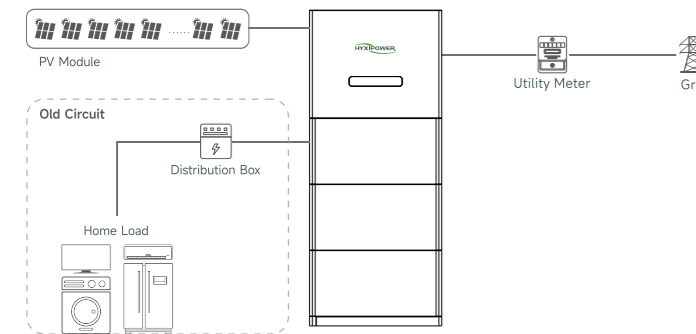

- Step 1: After disconnecting the power supply, take the GRID cable from GRID service entrance(AFTER utility meter), through the conduit entry hole of GRID.
- Step 2: Make the AC cable with the OT terminal. Secure the GRID cable to the corresponding terminals with "M6*15 L/N screw".
- Step 3: Make the BACKUP cable with the OT terminal. Secure the BACKUP cable to the corresponding terminals with "M6*15 L/N screw".
- Step 4: Take the BACKUP cable through the conduit entry hole of BACKUP. Connect the BACKUP cable to the main distribution box.

4.3.2 Partial Home Backup

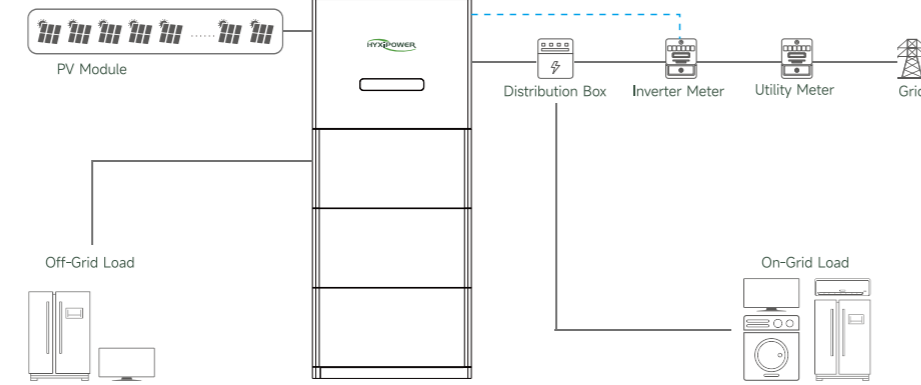

- Step 1: After disconnecting the power supply, take the GRID cable from main distribution box, through the conduit entry hole of GRID.
- Step 2: Make the AC cable with the OT terminal. Secure the GRID cable to the corresponding terminals with "M6*15 L/N screw".
- Step 3: Make the BACKUP cable with the OT terminal. Secure the BACKUP cable to the corresponding terminals with "M6*15 L/N screw".
- Step 4: Take the BACKUP cable through the conduit entry hole of BACKUP. Connect the BACKUP cable to the sub distribution box of off-grid load.

Partial Home Backup Installation require meter connection

- Step 1: Wire striping
- Step 2: Unscrew the COM port protective casing and pass meter cable through the COM port.
- Step 3: Put red seal ring into the bottle of body inside.
- Step 4: Place black seal ring on the green Locker.
- Step 5: Pass all parts through the wire in the following order.Crimp the 4pin copper core on the green locker and tighten it.
- Step 6: Screw all parts together and connect the water-proof 4pin connector to inverter module meter port.

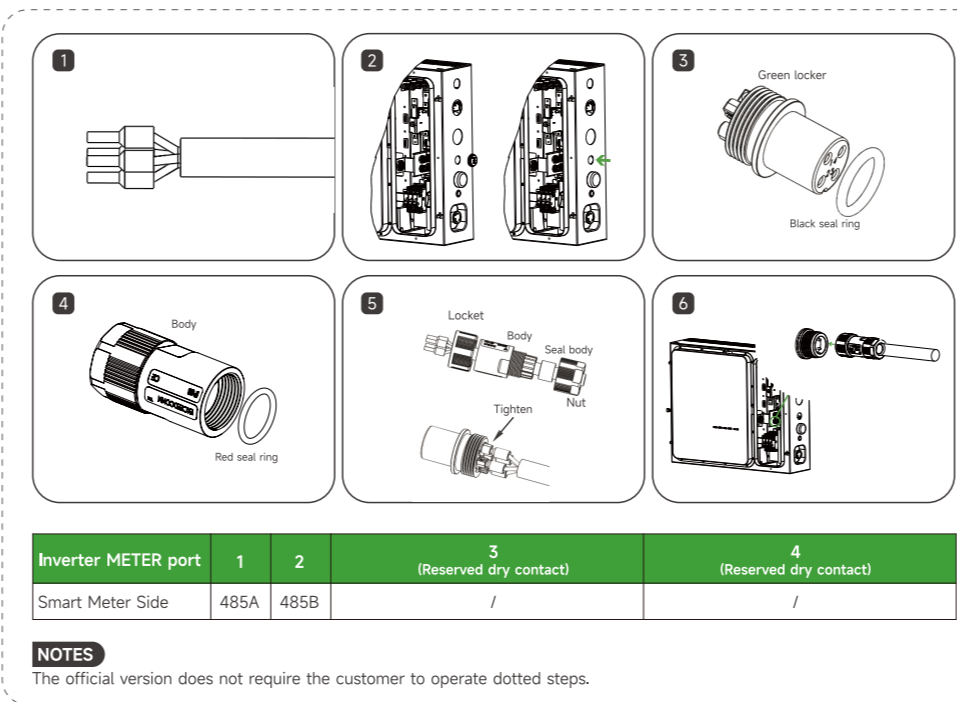

INV-meter connection meter side, INV and meter connected by RS485 2pin cable. For more details please refer to the manual in the meter package.

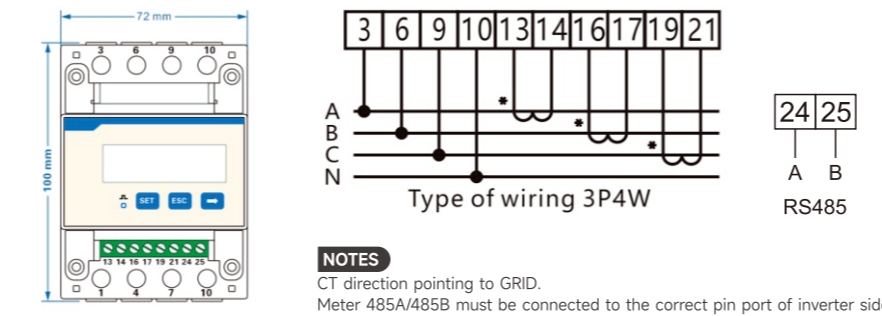

5 Communication Connection

Please select one of the following "WIFI module" or "4G module".

WIFI module

- Step 1: Insert DCS into the DONGLE terminal and tighten it to ensure it is secure.
- Step 2: Connecting the tail end of the DCS to the head of the antenna.

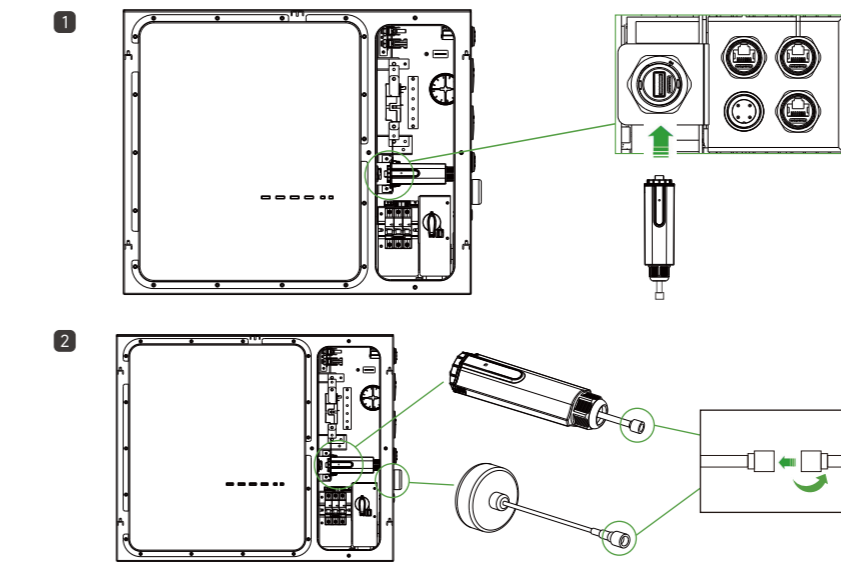

4G module

- Step 1: Remove the protective cover of DCS and insert the SIM card.
- Step 2: Install the waterproof cover of DCS.
- Step 3: Insert DCS into the DONGLE terminal and tighten it to ensure it is secure.
- Step 4: Connecting the tail end of the DCS to the head of the antenna.

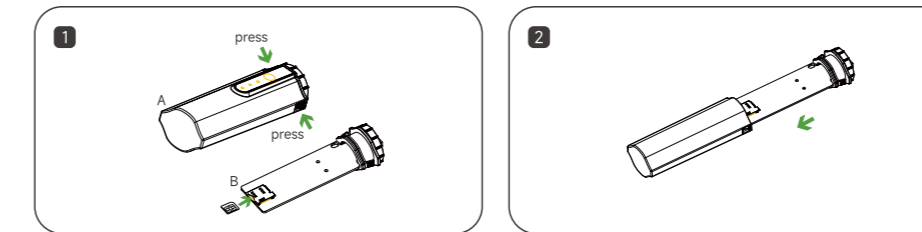

* Step 3 and step 4 are the same as the DCS wifi module

6 Wiring Completion and System Start-up

Normal Start-up

- Long press the power button for 5 seconds until the relay engagement click is audible.

First Start-up

(Only required when first set up or battery expansion)

After completing the system stacking (BEFORE wiring connection):

- Turn on the battery switch, wait for 5 seconds and turn off the battery switch, turn the battery switch on again. (For system authentication)

After completing all wiring connection

- Long press the power button for 5 seconds until the relay engagement click is audible.
- Turn on the PV switch.
- Turn on the breaker at the front end of the all-in-one to connect all-in-one to GRID.

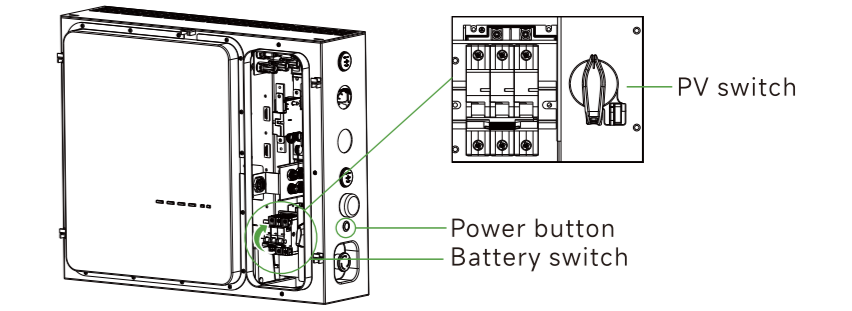

7 LED Indicator

No.	Name	Status	Indicator
1	SOC Green	Capacity	██████████
		ON-GRID	ON
		OFF-GRID	On 0.5s, off 0.5s
2	WORK Green	Standby	On 0.5s, off 1.5s
		Shutdown	OFF
		Normal	Off
3	ALARM Red	Self-Recovery Alarm (external)	On 0.5s, off 0.5s
		Self-Recovery Alarm (device)	On 0.5s, off 1.5s
		Error	On

8 System Commissioning

8.1 Installing the App

Method 1
Download the "HYXIPOWER APP" from the app store:

- App Store (IOS)
- Google Play

Method 2
Scan the QR code and download the APP:



App Download

8.2 App Quick Guide

For more information on using the HYXIPOWER APP, please scan the QR code.



App Quick Guide



support@hyxienergy.com

Product information is subject to change without notice.
© 2024 Zhejiang Hyxi Technology Co., Ltd. All rights reserved.

6.2.51.18.00100
QL_HYX-H11.5K-HSPA_V1.6-202508_US