



# Sub-1G Microinverter Installation Guide

Zhejiang Hyxi Technology Co., Ltd.

Mar. 2024

Quality

Innovation

Efficiency

Win-win

# Contents

1

**Preparation**

2

Microinverters Physical Installation

3

DMU Physical installation



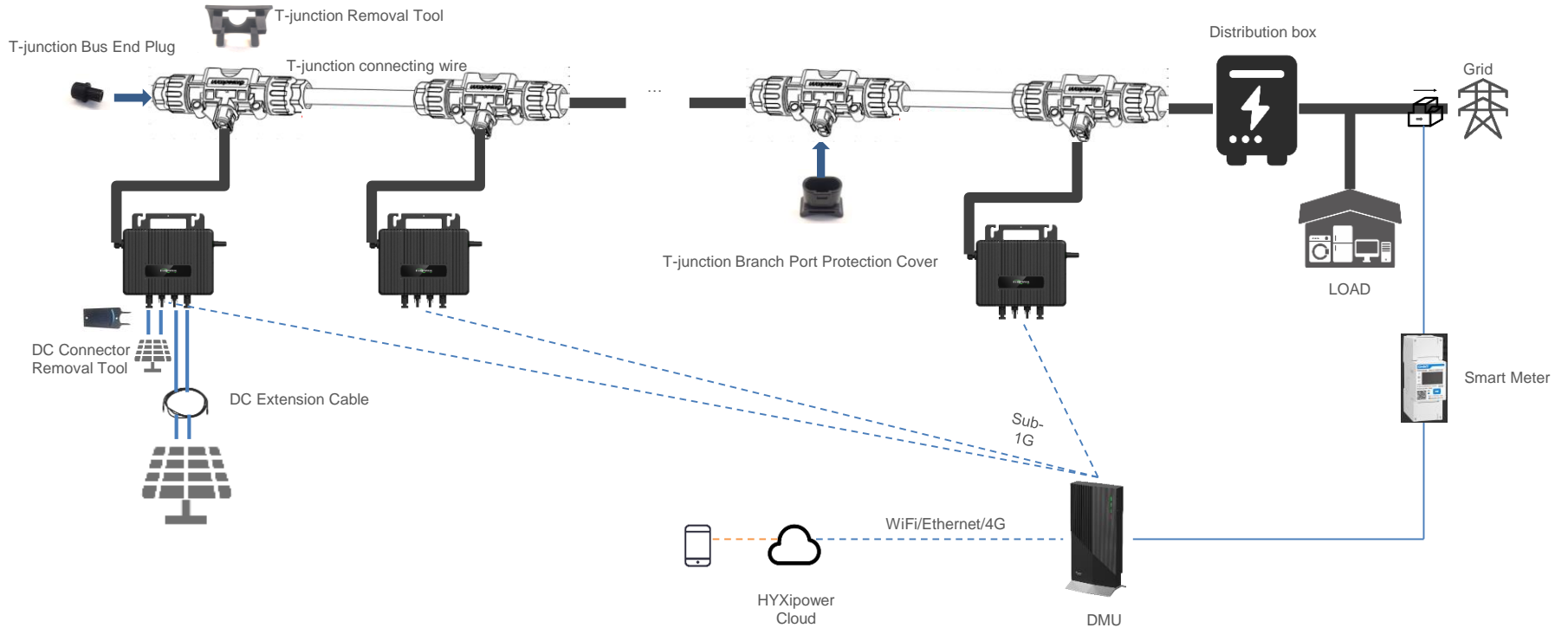

4

APP configuration







# Preparation 1 - Overall wiring diagram



## Preparation 2 - Products included in the above diagram

No.	Product Name	Picture	Description
1	Microinverters		Equipment for generating electricity
2	DMU(Wi-Fi/4G)		Connect Microinverter and the Internet
3	Meter		Measure power generation. Connect DMU to transmit data
4	Wi-Fi External antenna (Long one)		DMU external antenna (If the DMU is installed inside a metal box, under a metal concrete roof, or in a complex installation environment that results in weak signal strength, it is recommended to add an external antenna to the DMU to increase signal strength)
5	Sub-1G External antenna (Short one)		

## Preparation 3 - Products included in the above diagram

No.	Product Name	Picture	Description
6	DC Extension Cable		Used to extend the connection distance between micro inverters and photovoltaic modules
7	T-junction Bus End Plug		Used to protect unused bus connection ports on AC bus connectors at the end of AC branches
8	T-junction Branch Port Protection Cover		Used to protect unused branch connection ports on AC bus connectors
9	T-junction Removal Tool		Used to remove the upper cover of the AC bus connector for loading, unloading, or replacing the AC bus cable
10	T-junction Bus Connector		The AC bus connector is used to connect the AC output of the micro inverter to the AC bus
11	DC Connector Removal Tool		Used to disassemble the connection between the photovoltaic module and the input of the micro inverter
12	T-junction connecting wire		It can be used to connect the micro inverter to the distribution box for AC side convergence. The T-junction connecting wire is composed of T-junction bus connector and cables, and the spacing between the connectors on the bus is evenly distributed.

## Preparation 4- Products that need to be purchased separately



No.	Name	Description	Standard	Purchase Method
1	<b>Screws</b>	Used to fix Microinverter	M8*25	Buy from Local
2	<b>RS 485 Communication Cable</b>	Connect meter to DMU	RVVP double-core shielded wire, 0.5mm <sup>2</sup>	Buy from Local
3	<b>Ground wire</b>	For equipment grounding use	4~10mm <sup>2</sup>	Buy from Local
4	<b>DC Extension Cable</b>	Used to extend the connection distance between micro inverters and photovoltaic modules	DC-EC-1m	Buy from Hyxipower or Local

# Preparation 5 - T-junction installation instructions

## Single-row vertical installation

1-in-1 <1.6m

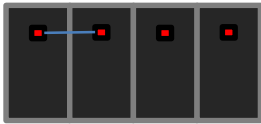

TJ-Cable-20T-19L-10AWG-1.6m-NA

2-in-1 <3m

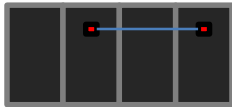

TJ-Cable-13T-12L-10AWG-3m-NA

4-in-1 <5.7m

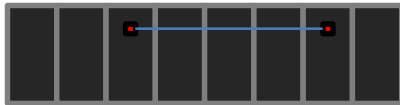

TJ-Cable-7T-6L-10AWG-5.7m-NA

## Double-row vertical installation

1-in-1 <1.6m

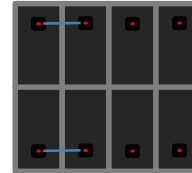

TJ-Cable-20T-19L-10AWG-1.6m-NA

2-in-1 <1.6m

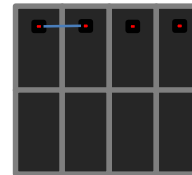

TJ-Cable-20T-19L-10AWG-1.6m-NA

4-in-1 <3m

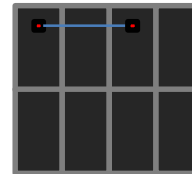

TJ-Cable-13T-12L-10AWG-3m-NA

Example: Microinverters



PV panels

AC cables

# Preparation 6 - T-junction installation instructions

## Single-row horizontal installation

1-in-1 <3m

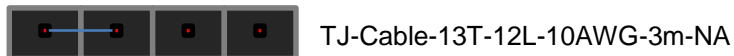

2-in-1 <5.7m



4-in-1 <11m (almost no such installation)



Example:

 Microinverters

 PV panels

 AC cables

## Double-row vertical installation

1-in-1 <3m

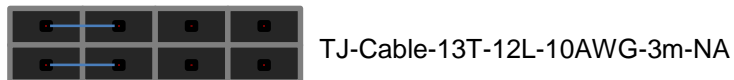

2-in-1 <3m

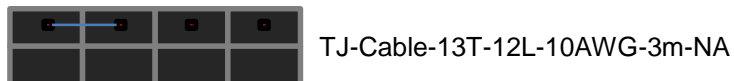

4-in-1 <5.7m





# Preparation 7 - Microinverter Introduction

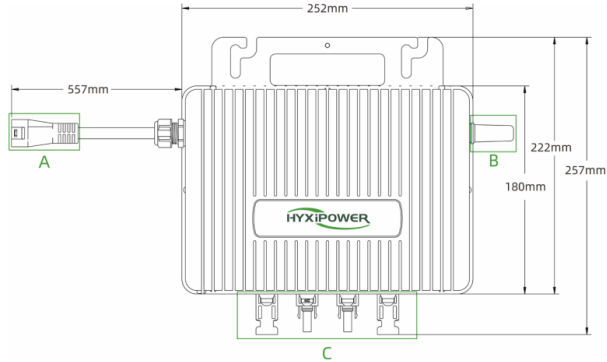

No.	Name
A	AC Branch Connector
B	Antenna
C	DC terminal



Light	Status	Meaning
Green	Fast flashes(1s gap)	Normal
	Fast flashes(3s gap)	Communication Fault
	Fast flashes(5s gap)	PV input fault
Red	Light on	Ground fault
	Fast flashes(1s gap)	Fault
	Fast flashes(1s gap)	AC fault

## Interface Layout

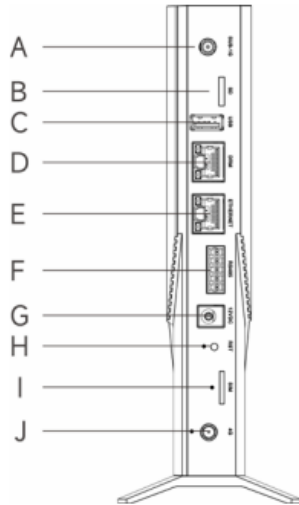

No.	Description
<b>A</b>	External Sub-1G antenna interface
<b>B</b>	SD card slot
<b>C</b>	USB port
<b>D</b>	DRM port
<b>E</b>	Ethernet port
<b>F</b>	RS485
<b>G</b>	Power port
<b>H</b>	Reset Button
<b>I</b>	SIM card slot
<b>J</b>	External WiFi/4G antenna interface

## Indicator Lights

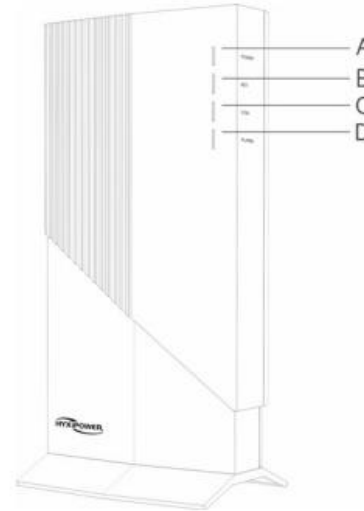

Name	Description
<b>POWER</b>	Power indicator
<b>NET</b>	Network communication (connecting to the server)
<b>COM.</b>	Microinverter communication (connecting to microinverter)
<b>FAULT</b>	Fault condition

Normal State: A, B, C are always on, D is off

## Preparation 9 - Tools Preparation



Wire stripper



Wire nippers



Tape measure



Cable tie



Screwdriver



Marker



Utility knife



Multimeter



Safety gloves



Hexagon wrench

# Contents

1

Preparation

2

**Microinverters Physical Installation**

3

DMU Physical installation

4

APP configuration

## Microinverter installation 1 - Install T-junction

**Step 1:** Prepare several sections of T-junction connecting wires according to the number of Microinverters to be installed on site.

**Step 2:** Removing the T-junction cable at the end.

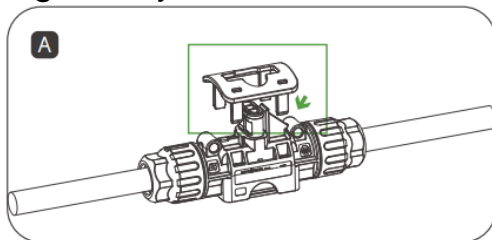

Use the T-junction removal tool to remove the lower cover.

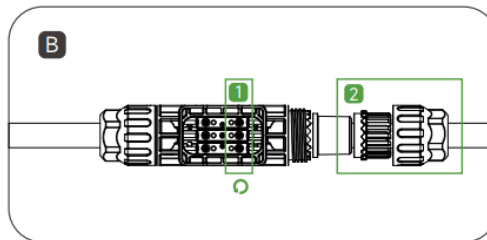

Loosen the inner screw, unscrew the nut, and remove the cable.

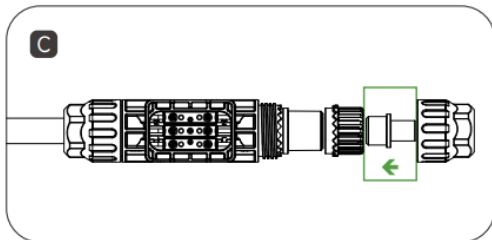

Install a T-junction bus end plug at the end of the T-junction.

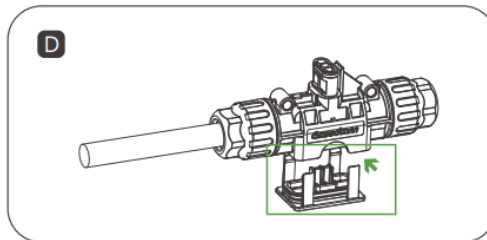

Insert the lower T-junction cover back into place and make sure it is secure.

## Microinverter installation 2 - Install T-junction Bus cables

### Step 3: T-junction and bus connection

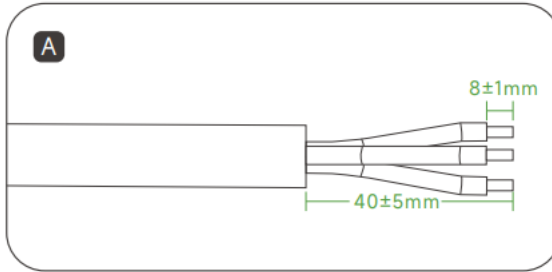

Prepare the AC cable by stripping the ends.

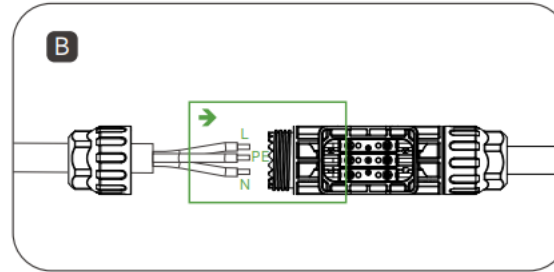

Insert the AC cable into the T-junction connector at the correct hole position.

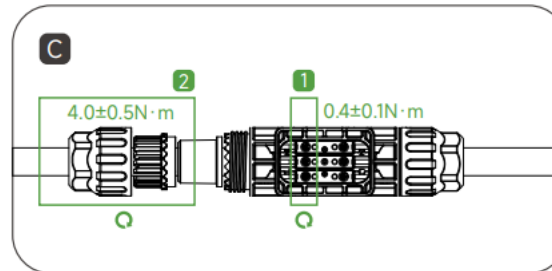

Tighten the screws, and then the nuts.

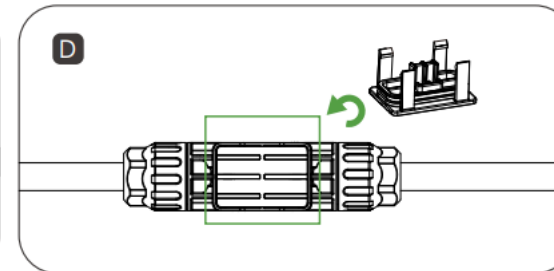

Insert the lower T-junction cover back into place, making sure it is secure.

# Microinverter installation 3 - Draw Installation Map

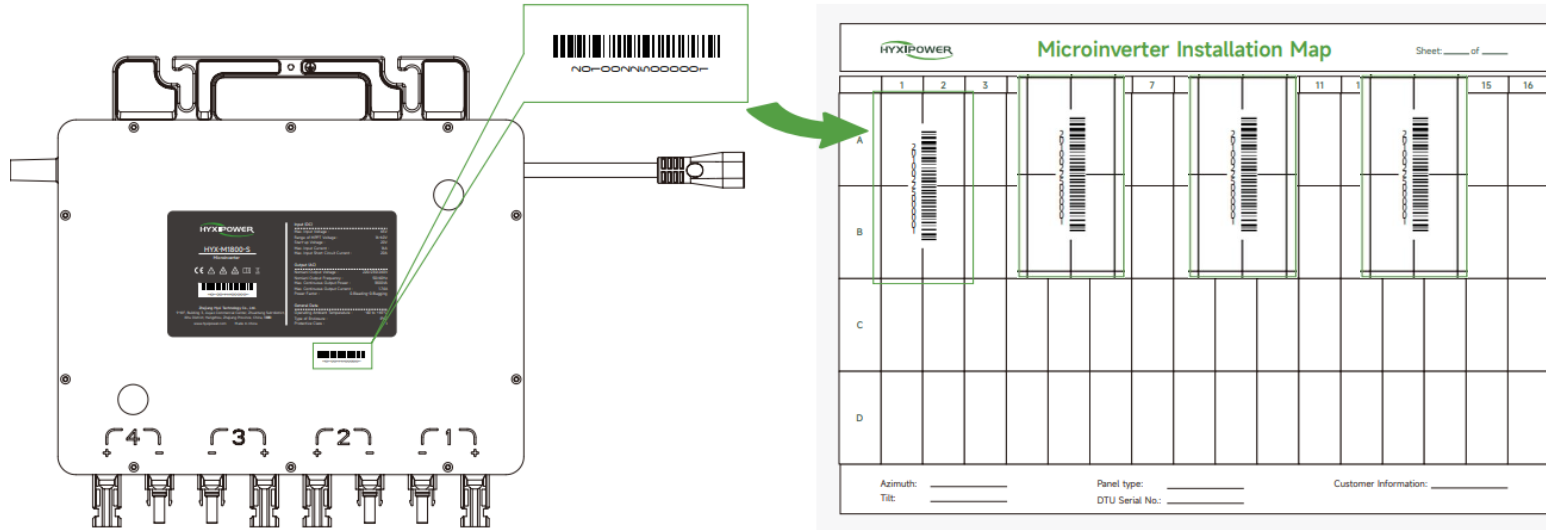

## Installation Map:

**Step1:** Record the location of the Microinverters to facilitate operation and maintenance

**Step2:** Facilitate the establishment of connection between DMU and microinverter

## Microinverter Installation 4 - Microinverter Installation

**Step 1:** Mark the installation position of the Microinverter on the bracket according to the layout of the photovoltaic modules.

**Step 2:** Fix the Microinverter on the bracket with M8\*25mm screw, then lock the screw.

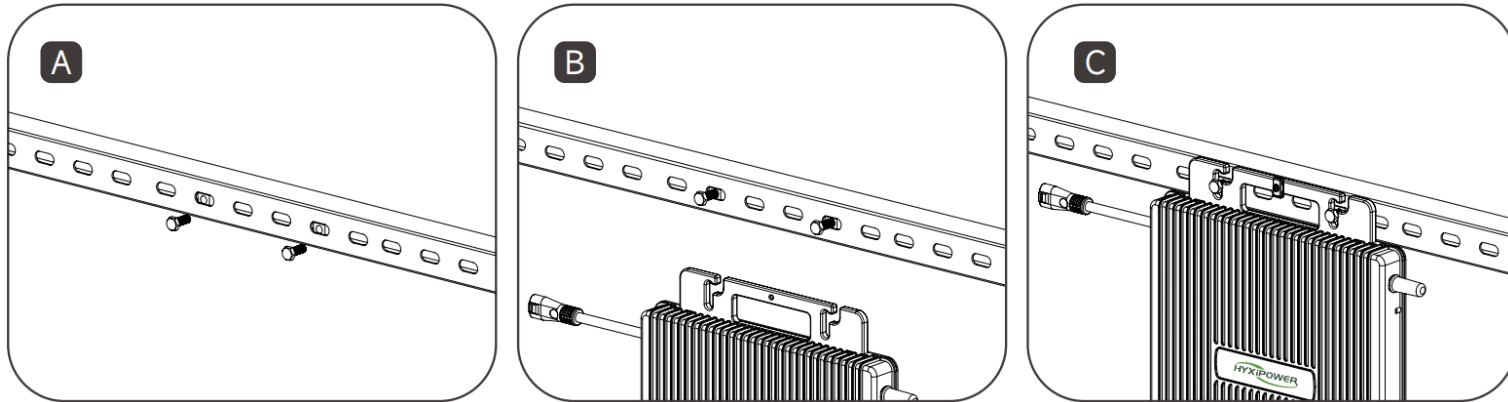



# Microinverter Installation 5 - Metal roof Scenario

## Equipment installation height



The distance between Microinverters and the Metal roof is less than 3 inches

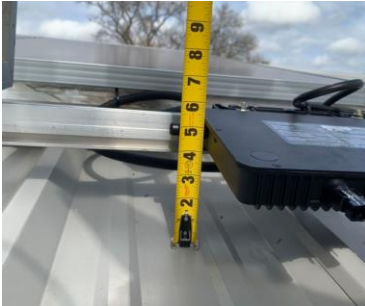

The distance between Microinverters and the Metal roof is bigger than 5 inches



## Equipment antenna placement



The antenna is at the peak of the Metal roof

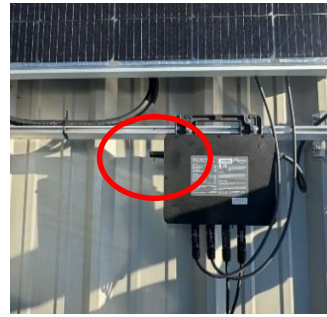

The antenna is between the two wave crests of the Metal roof



## Cable grooming



Cables tangled haphazardly around the antenna



Keep cables organized and away from antennas



During the Microinverters installation process, you need to pay attention to the height between Microinverters and Roof > 5 inches, the antenna needs to be placed between the two wave crests; the cables need to be neatly sorted and kept as far away from the antenna as possible.

## Microinverter Installation 6 - Connect Microinverter with T-junction

### Connect Microinverter with T-junction

Insert the output AC feeder connector of the microinverter into the T-junction bus connector  
Until hearing a 'click' sound. Ensure that the installation is tight.

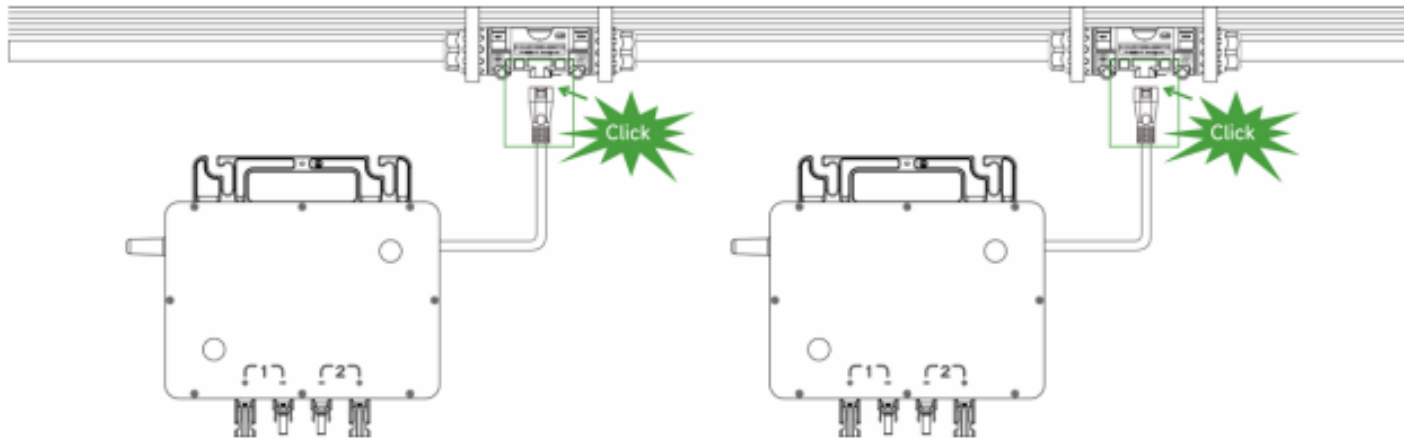

## Microinverter Installation 7 - Connect PV module

### Connect PV module

1. Install the PV module above the microinverter.
2. Connect the DC output cable of the PV module with the input side of the microinverter.

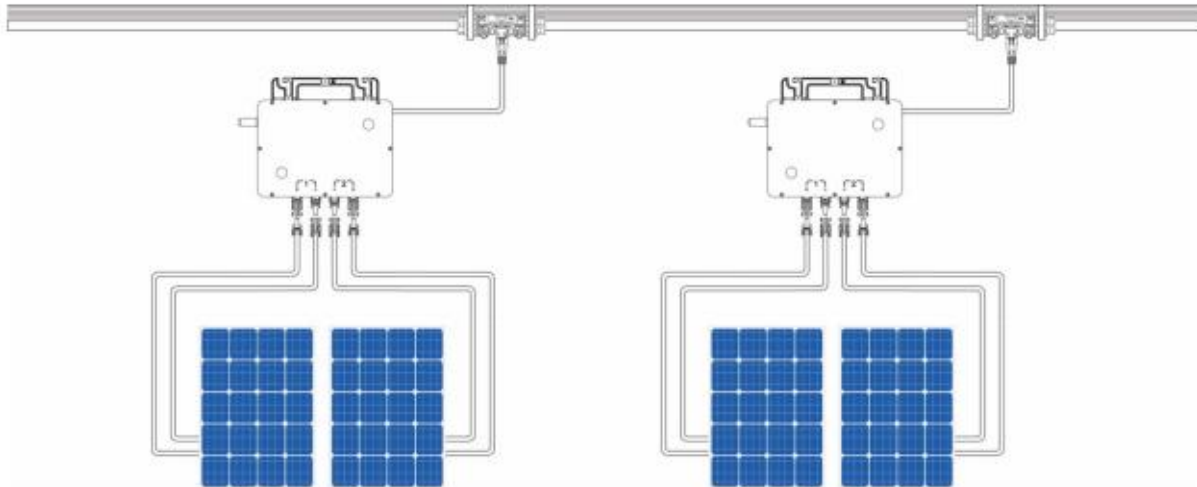

# Contents

1

Preparation

2

Microinverters Physical Installation

3

**DMU Physical installation**

4

APP configuration

# DMU Installation 1 - Accessories display



No.	Name
1	Power adapter
2	Screws
3	Mount
4	Fixed base
5	Quick installation guide
6	Installation map
7	DMU

## DMU Installation 2 - Under roof Scenario

---

Install on desktop



Wall-mounted



Installation video: [https://webfile.hyxipower.com/soft/20240102/Installation-Video\\_HYX-DMU-4G\\_Ver1.0-202311.mp4](https://webfile.hyxipower.com/soft/20240102/Installation-Video_HYX-DMU-4G_Ver1.0-202311.mp4)

## DMU Installation 3 - Metal Roof Scenario



### Example



Microinverters  
(under PV panels)



Photovoltaic panel



Waterproof box & DMU

### Please note:

1. The installation angle of the Sub\_1G antenna needs to be vertically upward, and there should be no metal obstructions around it.
2. In order to ensure the stability of the signal, the location of the DMU should be placed in the center of all Microinverters, if multiple DMUs need to be installed, each DMU should be placed in the center of its respective area (as shown in the picture above).
3. If the DMU signal in a single waterproof box cannot cover the Microinverters in all areas, need to consider install multiple waterproof boxes and DMUs in multiple locations to ensure the signal.

## DMU Installation 4 - Metal roof Scenario

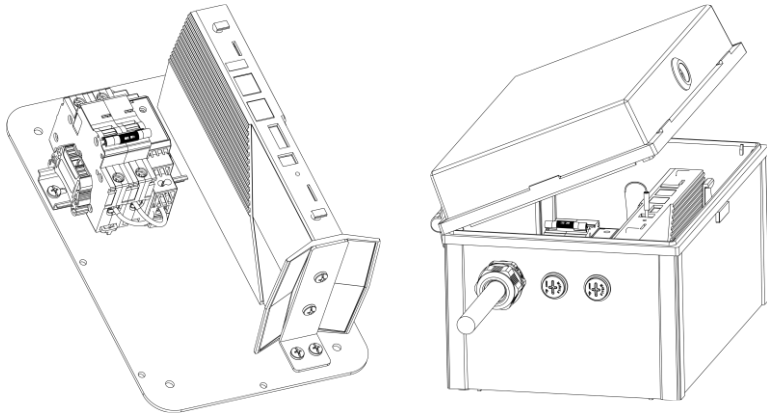

Place WiFi DMU in waterproof box on metal roof and use External antennas



External antennas:

Short one: sub-1g antenna

Long one: 4g/WiFi antenna

Press the reset button 5 times quickly  
to switch modes (Internal to External)



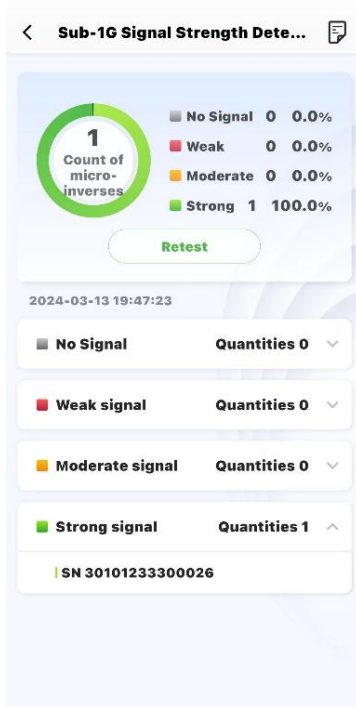

1. Please do not fix the position of the DMU in advance if possible.
2. The signal values of the DMU and the microinverter can be detected during software configuration.
3. Check [page 44-45 “APP configuration 3 - Check Signal Strength”](#) for details.

# Meter Installation (Optional)

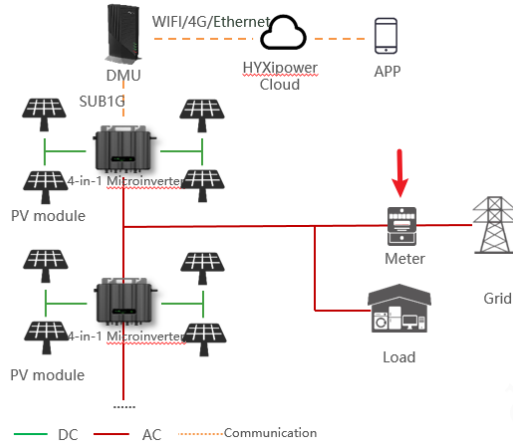

**Arrow points to the Grid.**

### Meter



### DMU



Recommended specifications of the meter-DMU 2-pin 485 cable:  
0.5 square mm RVVP shielded twisted pair wire.

# Contents

1

Preparation

2

Microinverters Physical Installation

3

DMU Physical installation

4

**APP configuration**

## Registration

1. Download HYXipower APP .
  2. Register the account of the person in charge of the organization.
- 

## Near-end Commissioning

- 1.Connect your phone to DMU
  - 2.Connect Microinverters to DMU
  - 3.Connect DMU to Internet
- 

## Check Signal Strength

Check signal strength between DMU and Microinverter

---

## Create a Plant

Create a Plant for users

---

# APP Configuration 1 - Download&Registration



The entire process requires 2 email accounts: **Organization and Owner**.

**Step 1:** Download the APP and **register** .

**Step 2 :** According to the country or region, select **server**, select **organization** , fill in the relevant information and **register**.

## Method 1

Search "Hyxipower " in the App Store

- APP store (IOS)
- Google play

## Method 2

Scan the QR code download the APP



More ▾

HYXiPOWER

Email/Phone No.

Password

Forgot Password? **Register Now**

I agree to the [Terms of Use](#) and I have read the [Privacy Policy](#)

Log In

Experience

Select Role

Please select the relevant server for your area

Select Your Server **European Server** >

If Your Role Is An Installer Or A Distributor, Please Register For The Following Role.

**Register as Organization** >  
Installer or Distributor

Register as Owner

**Register as Owner** >  
Plant Owner

If You Have Only Installed A Balcony Photovoltaic System, Please Register The Following Roles.

**Registered Balcony System Homeowner** >  
Balcony System Owner

< Register as Organization

Note: If your organization or company has registered for an organization account in this system, you do not need to register again. Please contact your administrator to add you to the member list

Organization/ Company Name Please Enter

Registration Method

Please Enter @hotmail.com ▾

Please Enter Send

Complete Info

Password Please Enter

Confirm Password Please Enter

Register

I agree to the [Terms of Use](#) and I have read the [Privacy Policy](#)

# APP Configuration 1 – Download&Registration - Admin registration

**Step 3 : Log in to your account** , select **Service - Member Management** , and then select " + " Invite members . It is recommended to choose **the administrator** role.

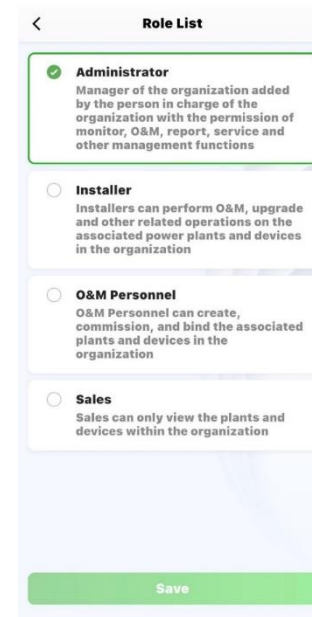
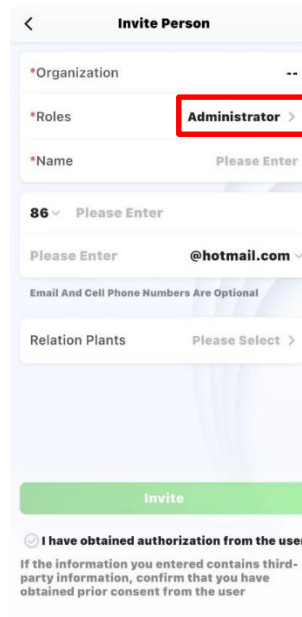
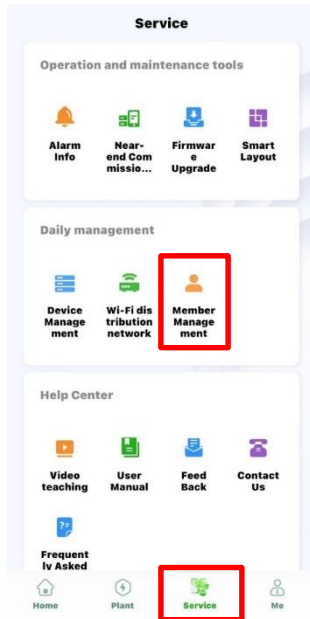

# APP configuration 2 - Near-end Commissioning

---



## Registration

1. Download HYXipower APP .
  2. Register the account of the person in charge of the organization.
- 

## Near-end Commissioning

1. Connect your phone to DMU
  2. Connect Microinverters to DMU
  3. Connect DMU to Internet
- 

## Check Signal Strength

Check signal strength between DMU and Microinverter

---

## Create a Plant

Create a Plant for users

---

## APP configuration 2 - Connect Phone to DMU

**Step 1:** Open the APP. Please **update APP** before debugging if there is one. Select **More** and choose your local server. Then choose **Near-end Commissioning**. It will take few seconds **download the latest firmware**. The file will be stored in the phone as a backup. If the phone has the latest firmware package, this step will be skipped.

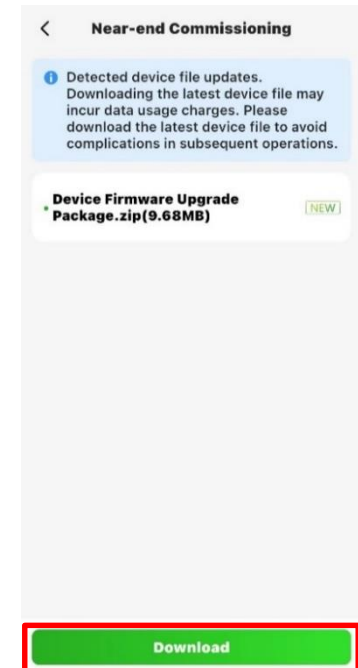
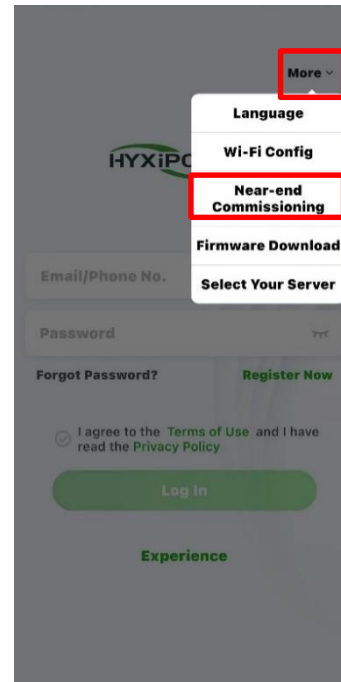
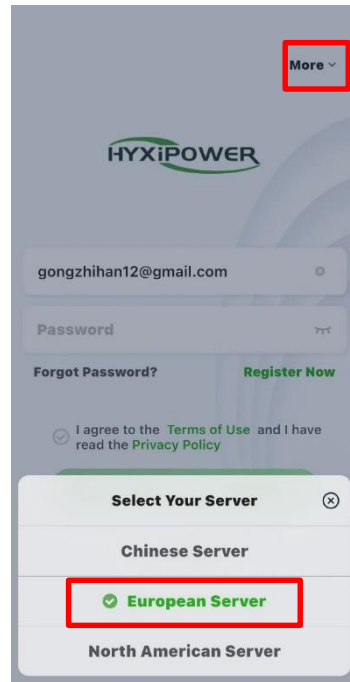
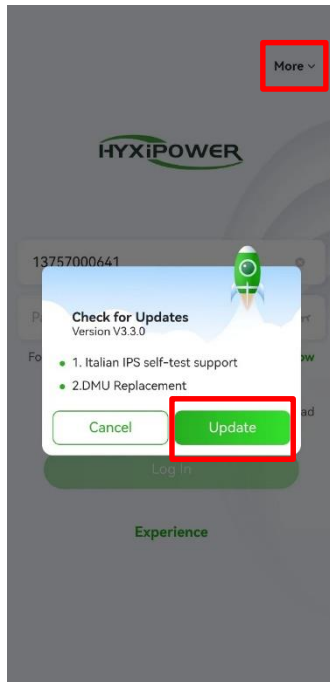



# APP configuration 2 - Connect Phone to DMU



**Step 2:** Scan the barcode of the DMU, Join WLAN network DMU-XXXXXXXXXXXX.

**Step 3:** If the barcode cannot be recognized, You can also choose to **connect manually**.

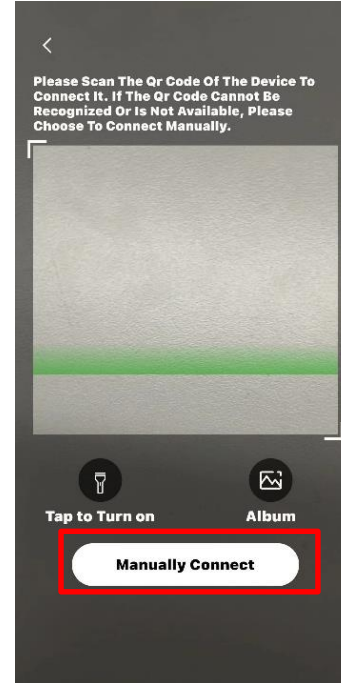
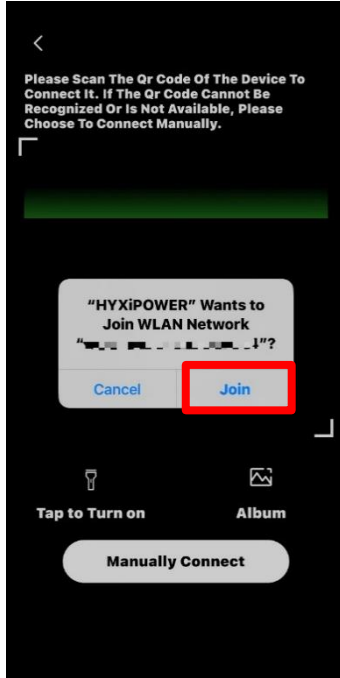
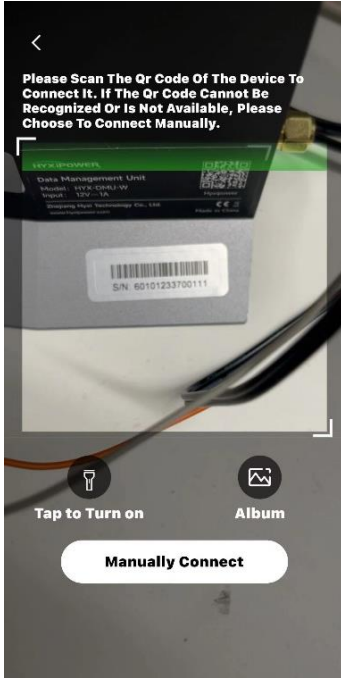

# APP configuration 2 - Connect phone to DMU

## IOS

Find the WIFI in settings of phone starting with DMU and connect: DMU-XXXXXXXXXXXXX;  
Password is **hyxi0607** or **12345678**, after connected, **return** to the "Hyxipower" APP and select **Next**.

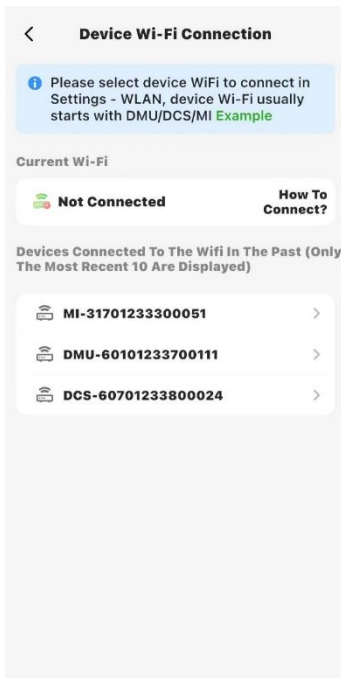

Keep the APP running in the background and enter the WiFi settings page **manually**.

Enter the WiFi password.

Then return to the APP.

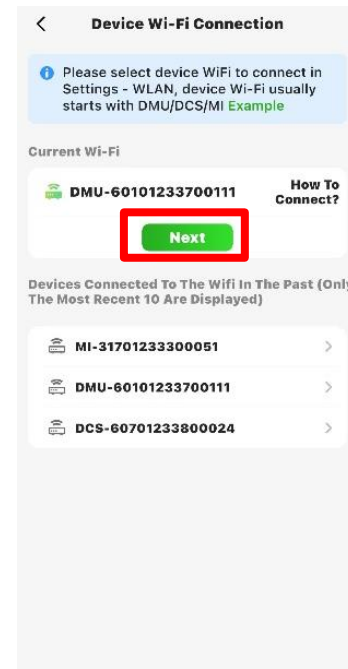
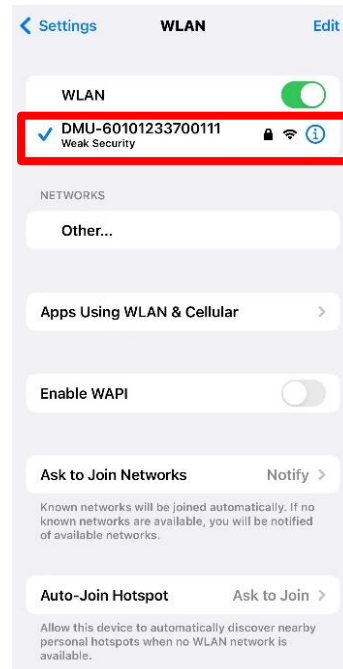
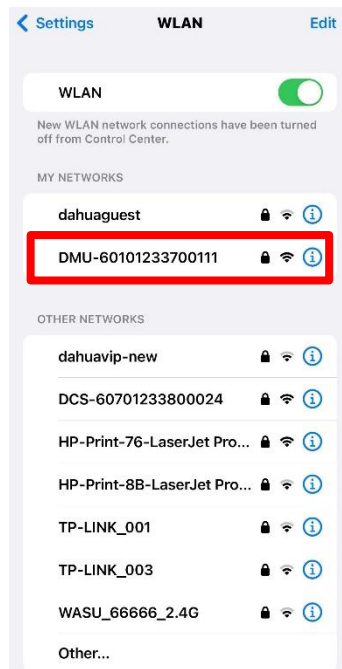

# APP configuration 2 - Connect Phone to DMU

## Android system :

Find the WIFI in settings of phone starting with DMU and connect: DMU-XXXXXXXXXXXXX;  
Password is **hyxi0607** or **12345678**, after connected, **return** to the "Hyxipower" APP and select **Next**.

### APP

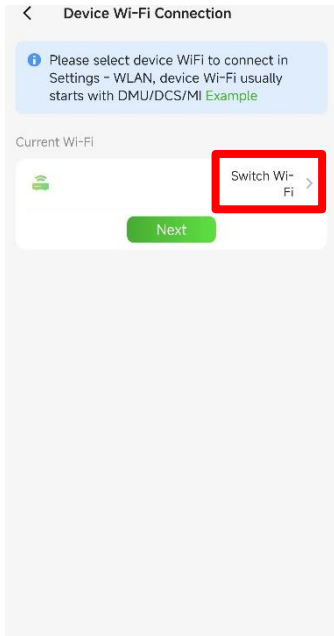

Keep the APP running in the background and enter the WiFi settings page **manually**.

Enter the WiFi password.

Then return to the APP.

### WIFI setting interface

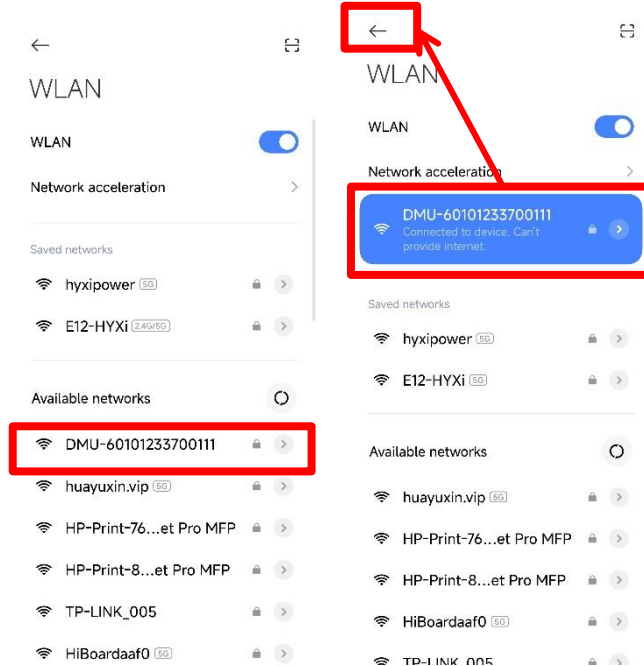

### APP

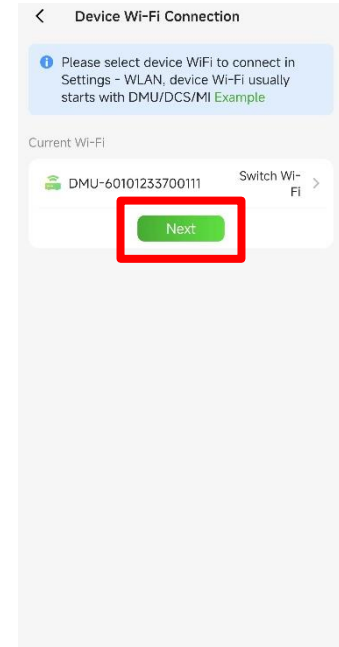

## APP configuration 2 - Connect Phone to DMU

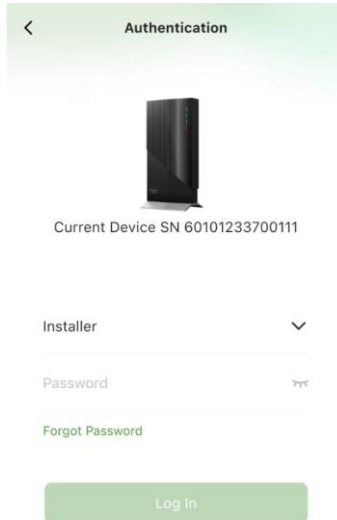

**Step 4:** Scan DMU's barcode and log in device : select Installer or Owner, Initial default password: hyxi0607 or 12345678

If you forget the password, you can quickly press the DCS RESET button 4 times to reset password.

# APP configuration 2 - Connect DMU to Microinverters



## Step 5: Enter quick settings

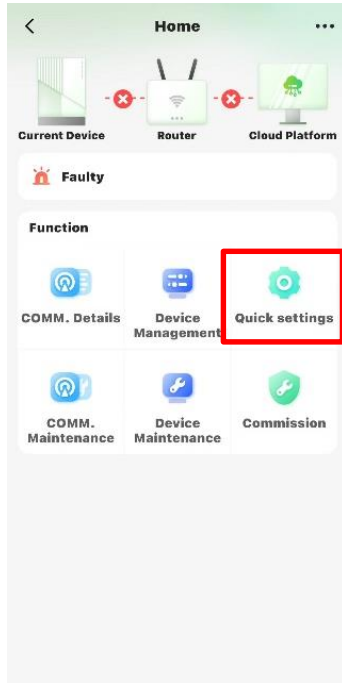

## Step 6: Select "Inverter" and scan the barcode of the Microinverters to connect them to DMU.

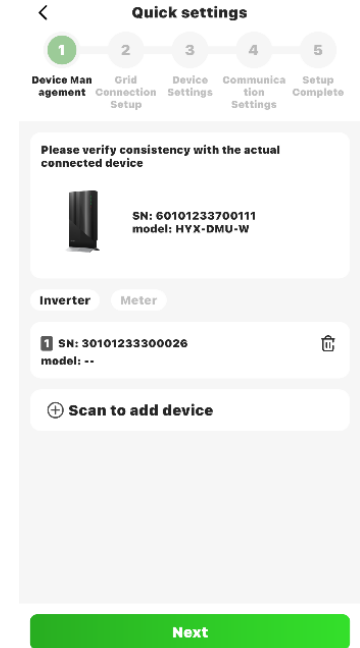
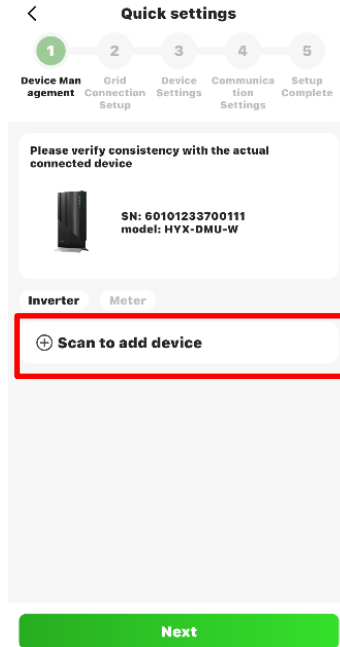

# APP configuration 2 - Connect DMU to Microinverters

Add Microinverters to the certain DMU by scanning the barcode on the installation map.

**HYXiPOWER** **Microinverter Installation Map** Sheet: \_\_\_\_ of \_\_\_\_

	1	2	3	4	5	6	7	8	9	10	11	12	13	14	15	16
A																
B																
C																
D																

Azimuth: \_\_\_\_\_ Panel type: \_\_\_\_\_ Customer Information: \_\_\_\_\_  
Tilt: \_\_\_\_\_ DTU Serial No.: \_\_\_\_\_

# APP configuration 2 - Meter



Step 8: Click meter and select "Grid type"

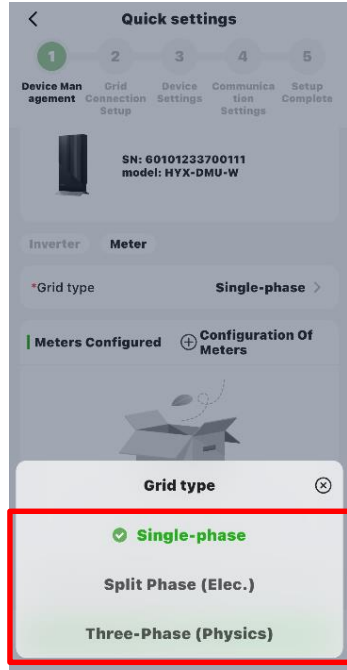
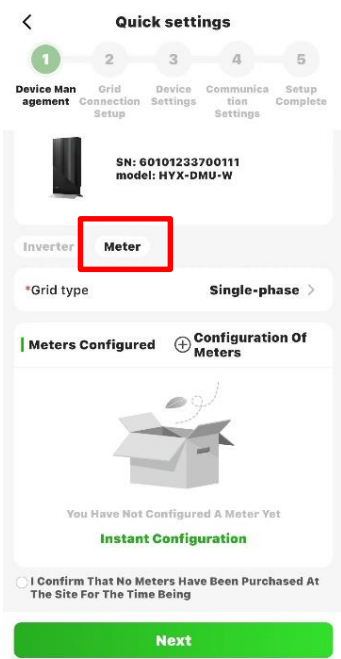

Step 9: Click "Configuration of Meters", fill in the number of meters (Usually 1) and address of meters (The default address is 1)

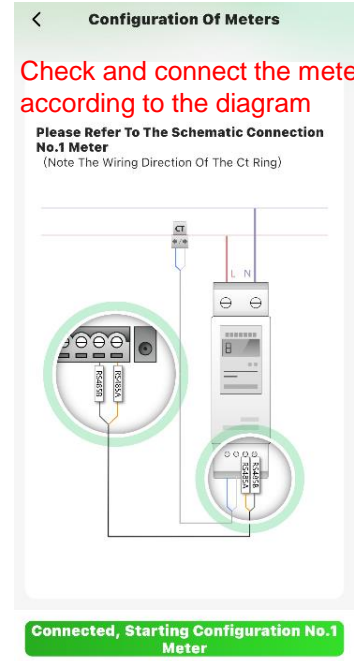
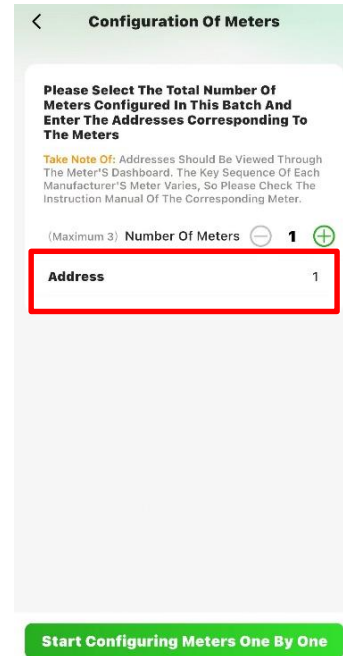

## APP configuration 2 - Meter

**Step 10:** Select the “**Mounting position**” for the current meter, and select the address of the **current meter**, and the APP will automatically assign an address to the current meter.

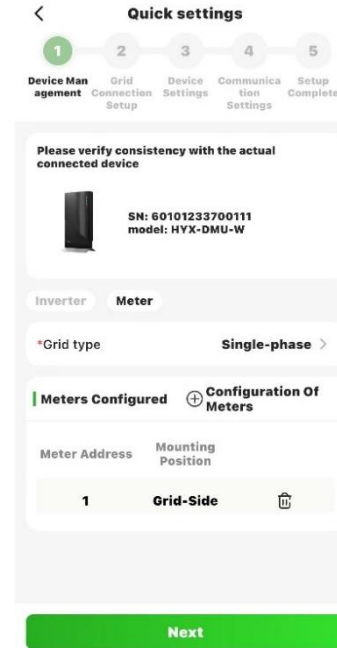
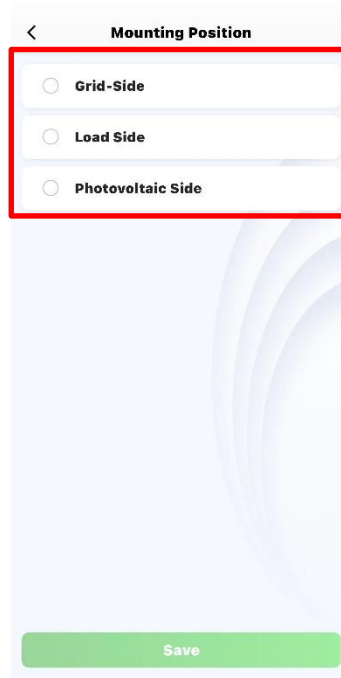



# APP configuration 2 - Setup Time Zone and Grid code

**Step 11:** Enter the grid connection Setup and set the time zone and grid code according to local regulations

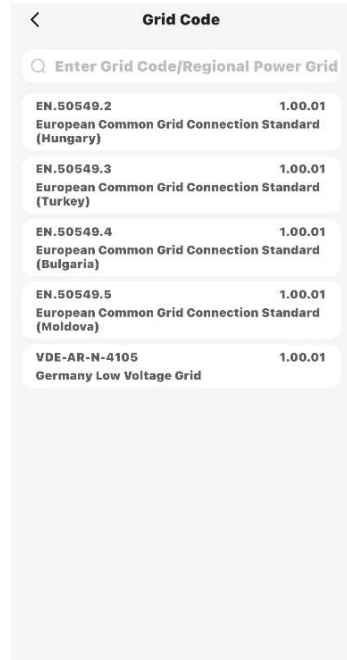
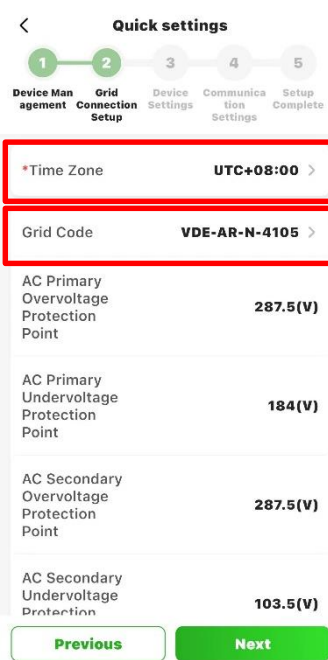

**Step 12:** Setup Export Control, Choose whether to feed power to the grid

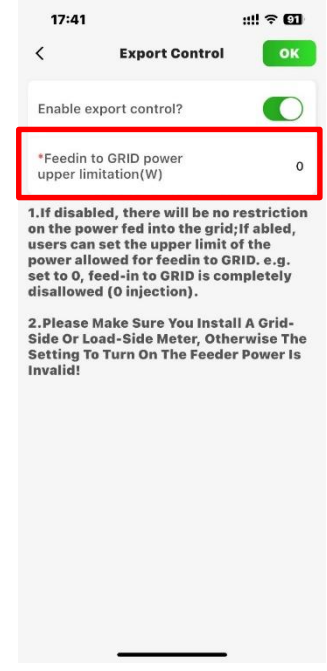
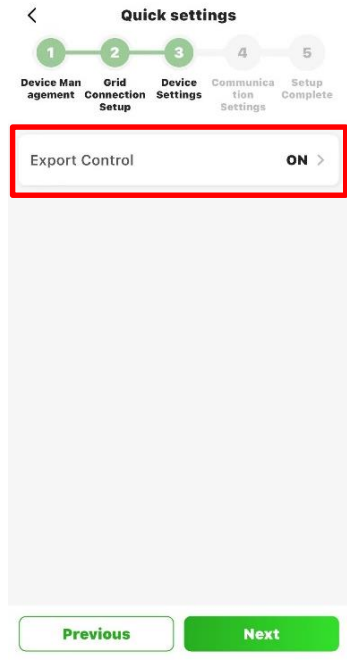

## APP configuration 2 - Connect DMU to Internet

**Step 13: Communication settings**, Choose your local **server**, fill in the **Wi-Fi name and password** for wireless mode. Confirm the automatic IP acquisition switch is **ON** for wired connection mode. No need to fill in the **APN, username and password** for the **4G version wireless mode**. The next step is to wait for the device to connect to the Internet.

Android users can automatically obtain the corresponding wifi name

IOS users need to manually input the WiFi name

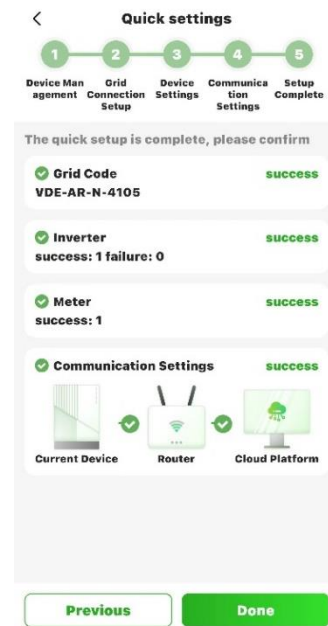
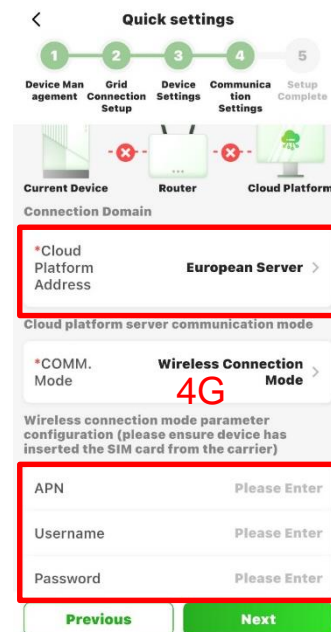
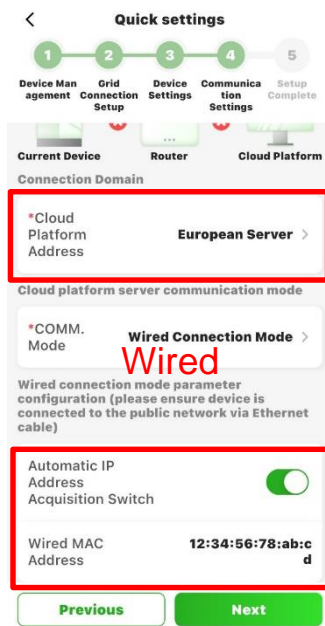
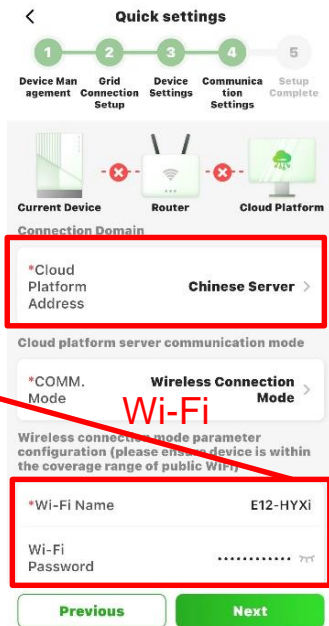
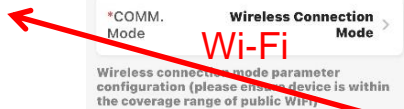

# APP configuration 1 - Check Signal Strength

---



## Registration

1. Download HYXipower APP .
  2. Register the account of the person in charge of the organization.
- 

## Near-end Commissioning

1. Connect your phone to DMU
  2. Connect Microinverters to DMU
  3. Connect DMU to Internet
- 

## Check Signal Strength

Check signal strength between DMU and Microinverter

---

## Create a Plant

Create a Plant for users

---

# APP configuration 3 - Check Signal Strength

**Step 1:** Check the sub-1g signal between microinverters and each DMU through **COMM.Maintenance**

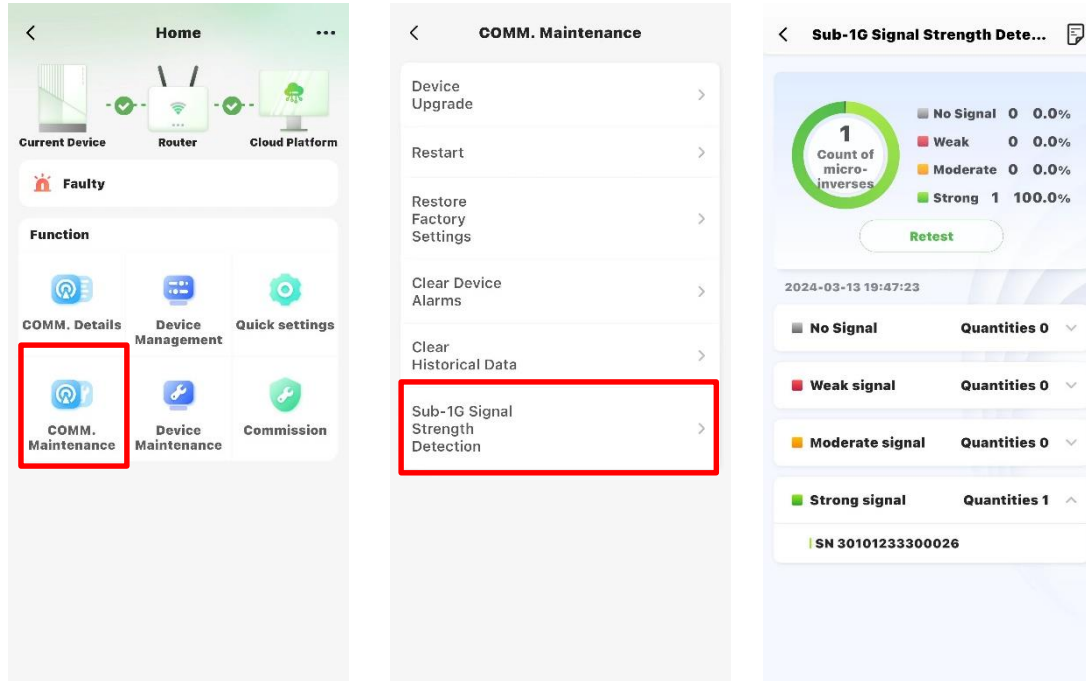

# APP configuration 3 - Check Signal Strength

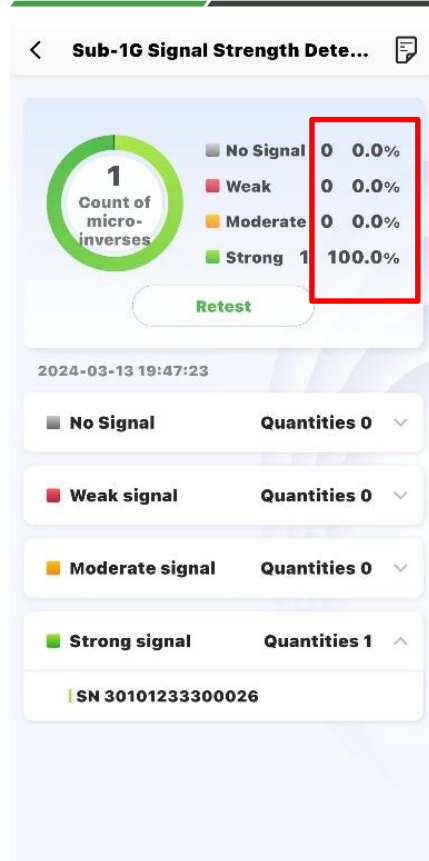

The current proportion of different signal equipment.

**Step 2:** Check the microinverters with “No Signal” and “Weak Signal”, and adjust the installation method of the Microinverter and the installation position and quantity of DMU to ensure that the signals of all devices are above “Moderate Signal”.

**Step 3:** See pages 17 and 23 for details.

## APP configuration 4 - Create a Plant for Owner

---



### Registration

1. Download HYXipower APP .
  2. Register the account of the person in charge of the organization.
- 

### Near-end Commissioning

1. Connect your phone to DMU
  2. Connect Microinverters to DMU
  3. Connect DMU to Internet
- 

### Check Signal Strength

Check signal strength between DMU and Microinverter

---

### Create a Plant

Create a Plant for users

---

# APP configuration 4 - Create a Plant for the owner

**Step 1:** Disconnect the phone from the DMU's WiFi.

Make sure your phone has Internet access

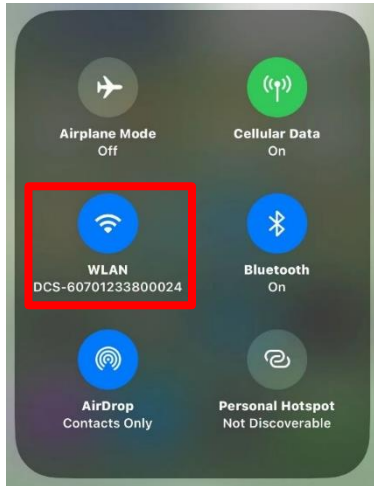

**Step 2:** Log in to your **organization account**, click the **Add Plant** button

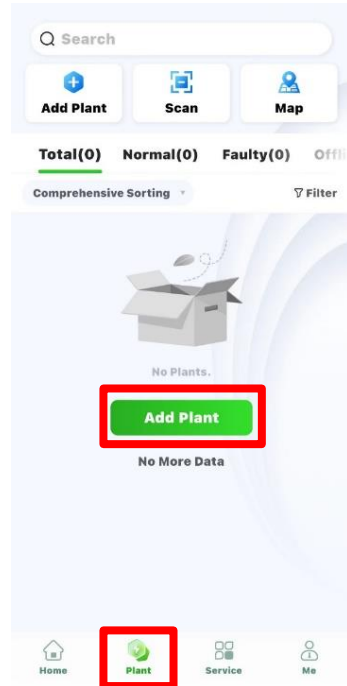

**Step 3:** Scan the QR code of the DCS or add it through the Recently debugging device

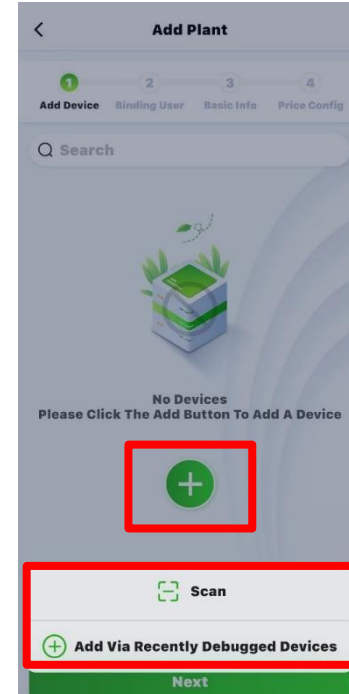

# APP configuration 4 - Create a Plant for the owner

**Step 4: Add owner - manually add or scan the owner's QR code to bind.** Manually add - enter the email address or mobile phone number of the Plant owner. If the owner is not registered, click to help him register and bind. The system will generate a random password and send a text message or email to the registered account

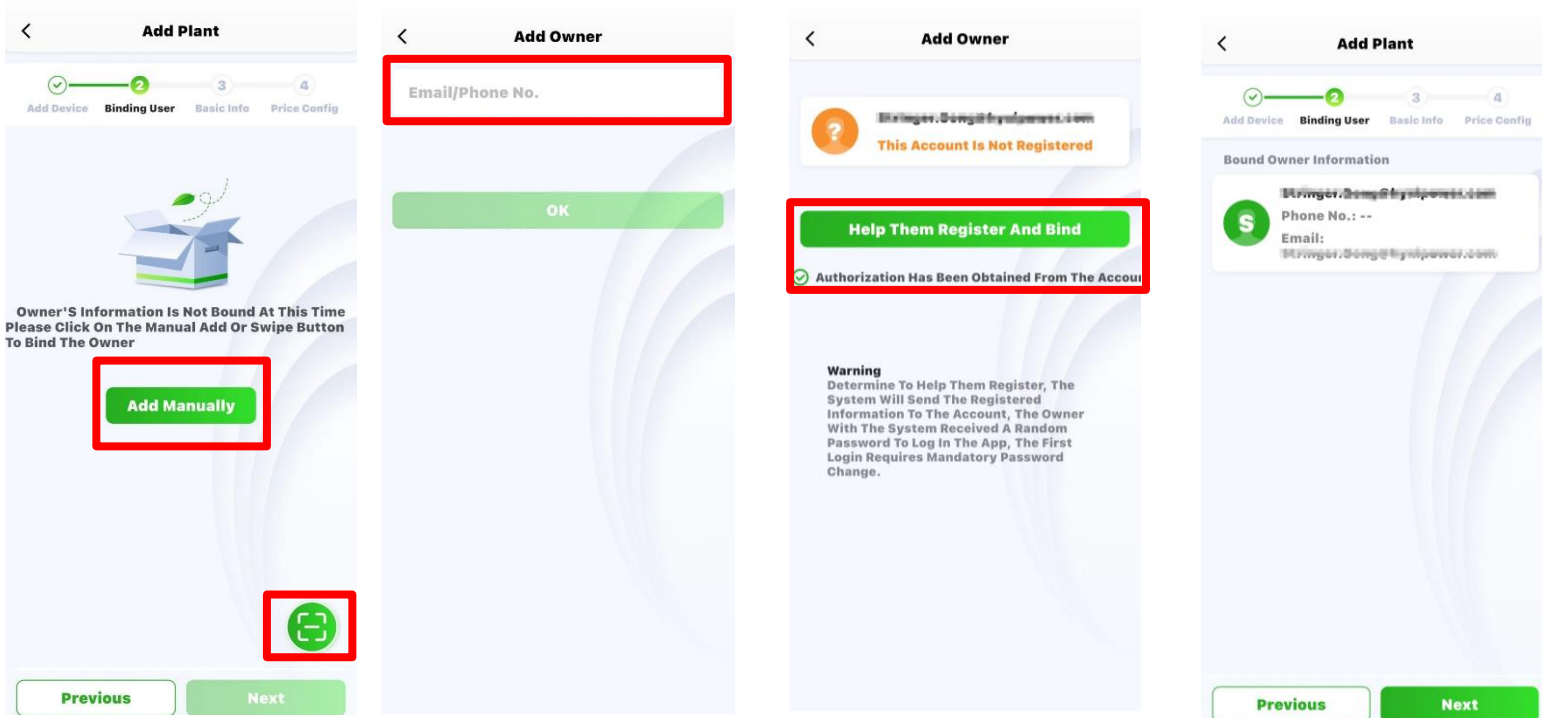



# APP configuration 4 - Create a Plant for the owner

Step 5: Fill in Plant name-Plant type(House hold Use)-Region-Time Zone

Step 6: More Info-Next.

**Add Plant**

1 2 3 4  
Add Device Binding User Basic Info Price Config

\*Plant Name recoderag@163.com20 24-04-10

\*Plant Type Household Use >

Region 中国浙江省杭州市滨江区

Plant Address 浙江省杭州市滨江区长河街道滨兴路1399号-大华股份(总部)

\*Time Zone (UTC+08:00) Beijing, Chongqing, Hong Kong, Urumqi >

More Info

Previous Next

**Plant Type**

Please select the correct power station type

**Household Use**  
For small and medium-sized projects, typically under 100 kW, dominated by microinverters, residential energy storage, and string systems

**Industry and Commerce**  
For large-scale commercial and industrial projects, typically under 100 kW, dominated by high-capacity household energy storage and high-capacity string systems

**Energy Storage**  
For projects dominated by commercial and industrial energy storage cabinets, typically over 100 kW

**Add Plant**

1 2 3 4  
Add Device Binding User Basic Info Price Config

\*Plant Name recoderag@163.com20 24-04-10

\*Plant Type Household Use >

Region 中国浙江省杭州市滨江区

Plant Address 浙江省杭州市滨江区长河街道滨兴路1399号-大华股份(总部)

\*Time Zone (UTC+08:00) Beijing, Chongqing, Hong Kong, Urumqi >

More Info

Previous Next

**Add Plant**

1 2 3 4  
Add Device Binding User Basic Info Price Config

Photovoltaic installed capacity Please Enter kWp

Number of Strings Please Enter

Grid Connection Type Feed All to Grid >

Contribution Type Full Payment by Owner >

Contact Phone No Please Enter

Remarks Please Enter

Plant Image Upload

Show Less

Previous Next

# APP configuration 4 - Create a Plant for the owner

**Step 6:** Fill in Electricity Price Type, Currency and Revenue per kWh, select Finish, and the Plant is successfully created.

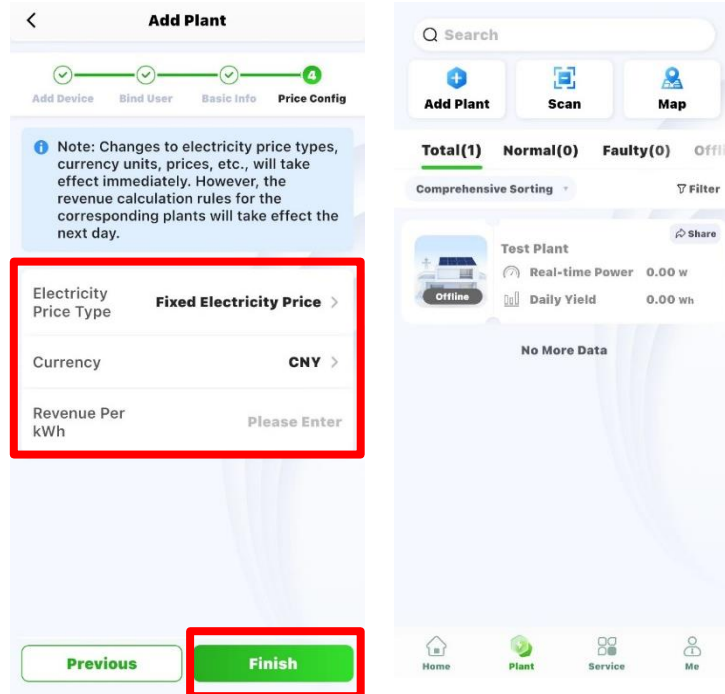

# Installation Acceptance

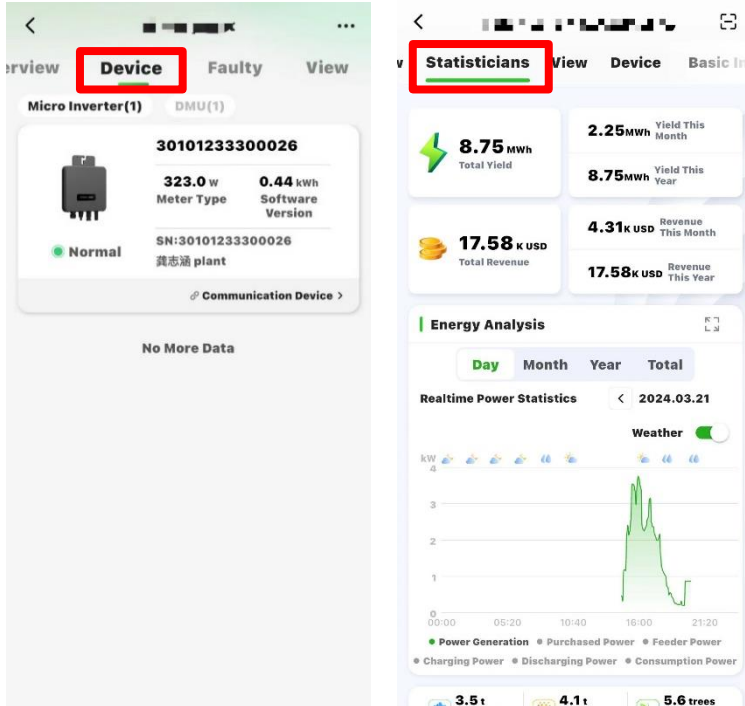

**Step 1:** Select **Plant - User's Plant - Device**, and ensure that the online state of device is correct.

**Step 2:** After installation is completed, continuously monitor for more than half an hour, select **Statistics - Energy Analysis**, view the realtime power statistics curve, and ensure that the Plant has started generating electricity normally.

**After confirming that all the above are normal, it indicates that the device installation and configuration is successful!**



# THANKS

Zhejiang Hyxi Technology Co., Ltd.

Quality

Innovation

Efficiency

Win-win

