



Single-phase String Inverter Installation Guide

Zhejiang Hyxi Technology Co., Ltd.

Quality

Innovation

Efficiency

Win-win

Contents

1

Preparation

2

Product introduction

3

Physical installation

4

APP configuration

Preparation 1- Program Overview

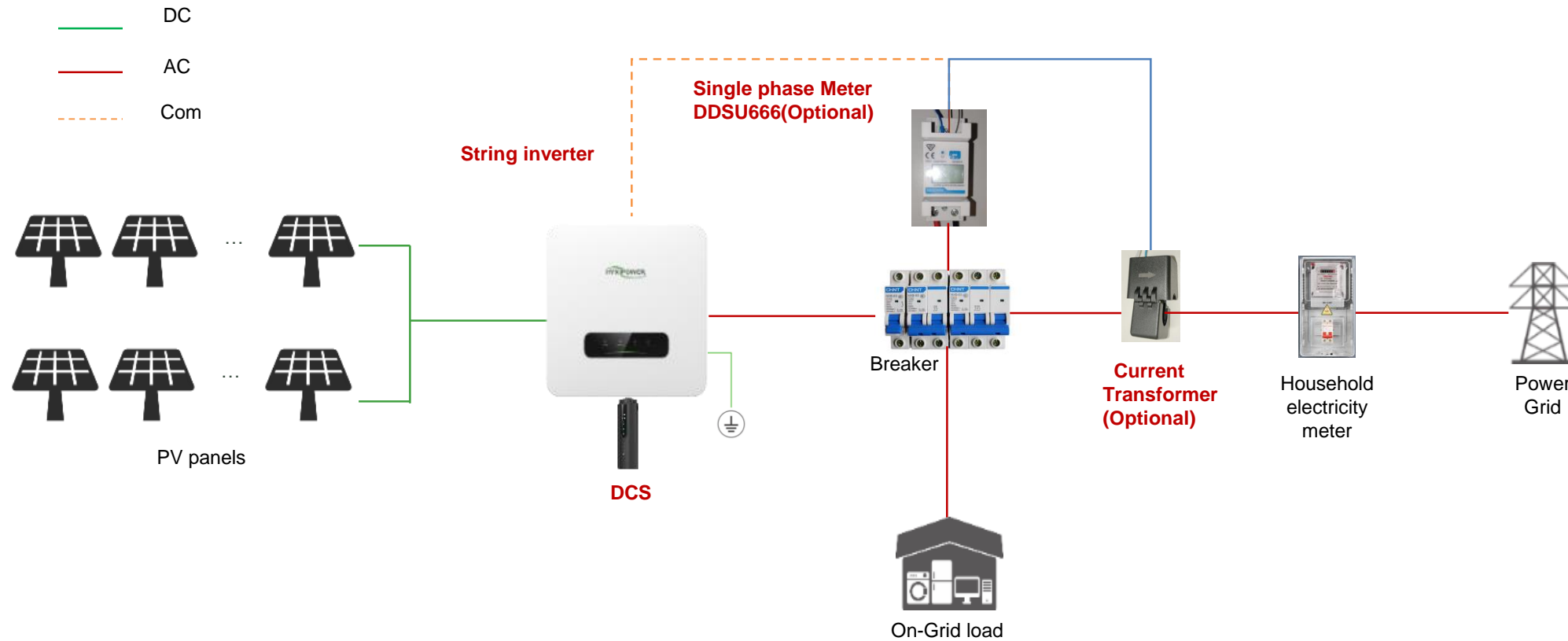

Before installation, the on-site environment should be surveyed.

Refer to the picture above to plan the equipment installation location and wiring scheme in advance.

Preparation 2- Material and Tools Preparation

Conduct a survey of the site environment before installation and make plans in advance

1. Plan the location of equipment in advance: the mounting location of the inverter and the placement of the battery (outdoor cement pouring needs to be considered to raise the ground)
2. Understand the on-site PV access situation, whether there are photovoltaic panels, and whether the current and voltage of the photovoltaic panels meet the specifications of the inverter. If it exceeds the specifications, the customer needs to be informed in advance to reduce the number of photovoltaic panels to avoid equipment damage
3. Check the location of the inverter and home air conditioner
4. According to the pre-installation conditions of the on-site environment, measure the required length of each cable, and purchase the cables required for installation in advance, as shown in the table on the right

Important! ! The following cable products are not provided and need to be purchased separately.

	Name	Description	Specification
1	PV cable	Cables used from photovoltaic panels to inverters comply with outdoor multi-core copper cable 1000V and 18A standards;	4~10mm ²
2	Communication cable	485 communication cable	RVVP double-core shielded wire, 0.5mm ²
3	AC output cable	AC side wiring of the inverter , use three-core outdoor copper core cables	4~10mm ²
4	Ground wire	For equipment grounding use	4~10mm ²

Tool preparation



Wire strippers



Crimping Tool



Electric drill



Heat gun



Screwdriver



Marker







Utility knife



Multimeter

Preparation 2 - Material

Product existing equipment list

No.	Name	picture	Description
1	Single phase String inverter		Includes an inverter host and a batch of inverter related accessories
2	Single phase electricity meter		Measure circuit voltage, current, power, etc.
3	Current Transformer		Induced current size, used with electric meter
4	DCS communication stick		After registering the device to the cloud server, it can be managed uniformly through the cloud platform.

Contents

1

Preparation

2

Product introduction

3

Physical installation

4

APP configuration

Product Introduction 1- Introduction to String Inverter

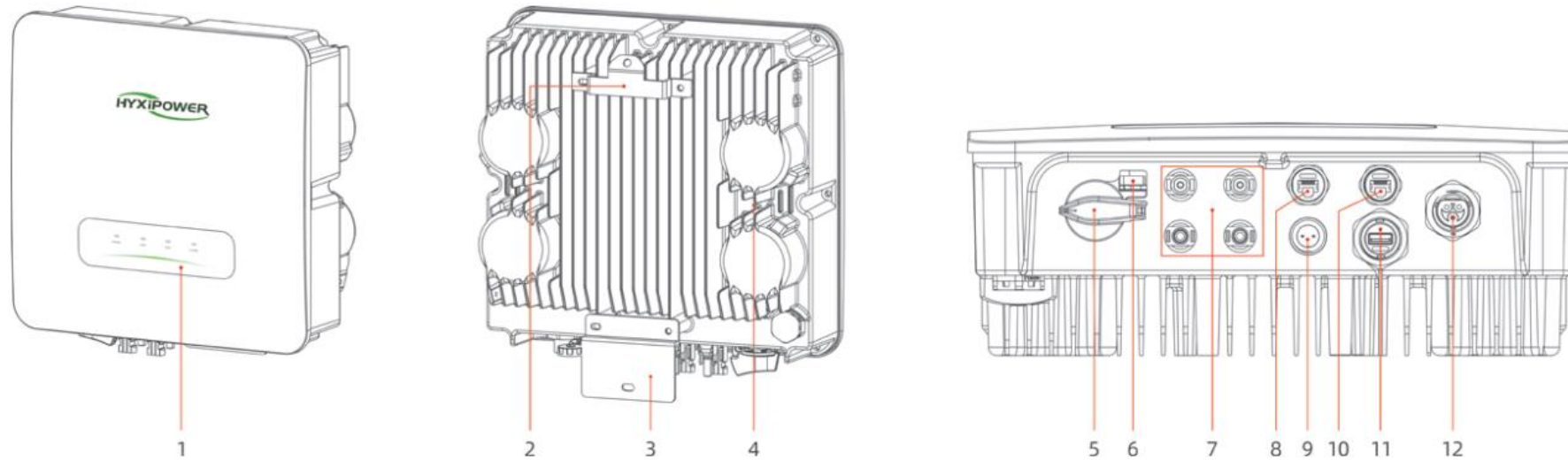

	Name	Description		Name	Description
1	LED Indicator Panel	Indicates the current operating status of inverter	7	DC Input Terminal (PV+/PV-)	Inverter-PV
2	Mounting Pegboard	Fixed inverter top	8	COM.1	RS485 communication
3	Mounting Bracket	Fixed inverter bottom	9	METER Port	Smart Meter
4	Fin Heat Sink	Heat dissipation and ventilation	10	DRM port	DRM function Reserved(Australia)
5	DC switch	On/Off DC input	11	DCS	Monitoring Port
6	DC switch lock	DC lock hole Reserved(Australia)	12	AC Output Terminal	AC output to GRID/UTILITY

Product Introduction 2- Inverter Accessories Introduction



No.	Description
1	Photovoltaic interface connector 1
2	Photovoltaic interface connector 2
3	DRM and COM communication connector
4	Meter connector
5	AC connector

Product Introduction 3 - DCS Introduction

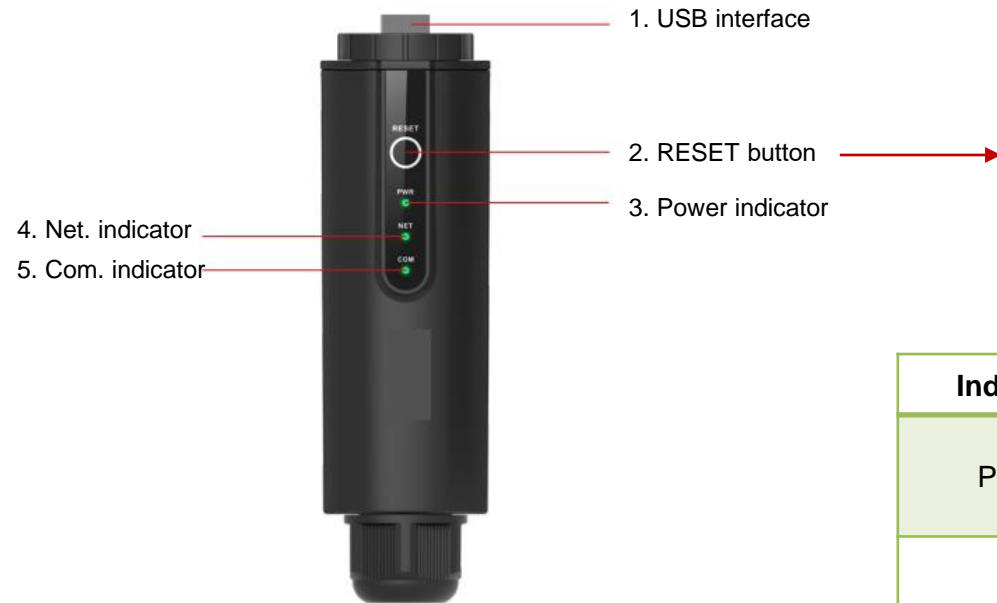

RESET button:

1. Press 2 times to restart
2. Press 3 times to enable local configuration (AP mode);
3. Press 4 times to restore factory settings

(Within 1 second between pressing)

Indicator	Status	Description
Power	On	Power ON
	OFF	Power OFF
NET.	Solid Green	Connected to server
	Flashing	Connecting to server
	OFF	Disconnected from server
COM.	Solid Green	Normal communication with inverter
	Flashing	Communicating with inverter
	OFF	Communication with inverter failed

Product Introduction 4 - Meter Introduction

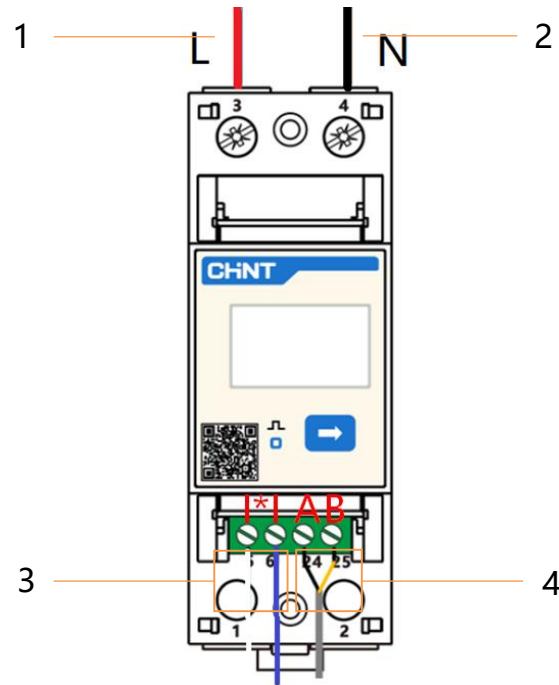

5

No.	Cable Name	Description
1	Live wire	Connect the live wire between the grid and the inverter
2	Neutral wire	Connect the neutral wire between the grid and the inverter
3	Current transformer communication wire	Connect current transformer
4	Inverter 485 communication wire	Communication wire between inverter and meter
5	Current Transformer	It is used to obtain the current of the alternating current on the grid side, which facilitates the inverter to control the power output Note: the arrow must point to the grid during installation

Contents

1

Preparation

2

Product introduction

3

Physical installation

4

APP configuration

Physical Installation 1 - Inverter Installation



The mounting bracket and inverter can be fixed as follows:

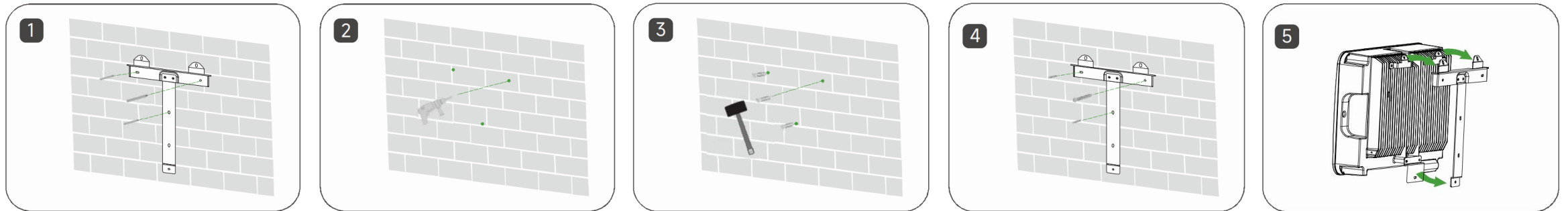

When installing multiple inverters, a distance of more than 300mm should be maintained between the two inverters.

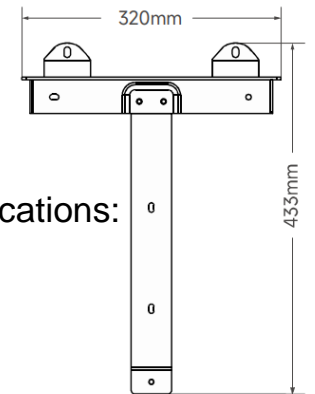
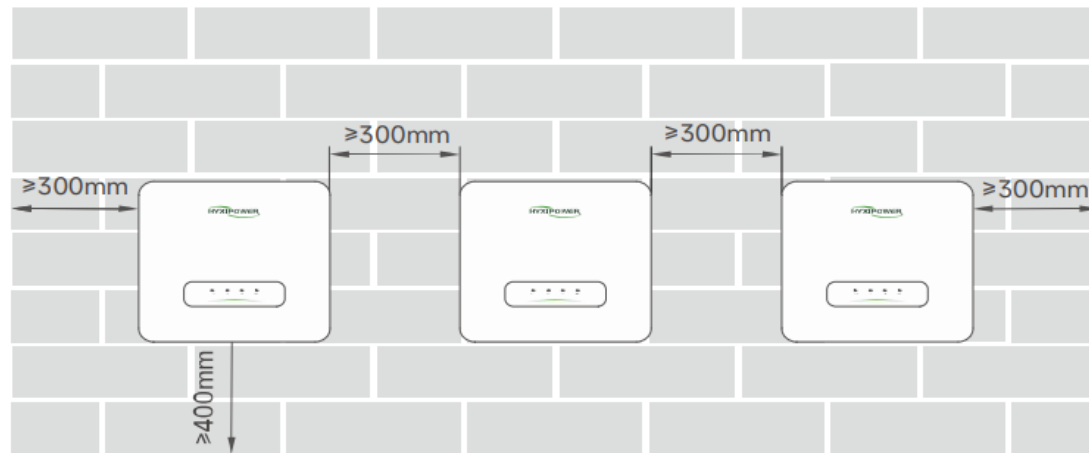

Bracket specifications:

Note: Before installing the equipment, please ensure that the photovoltaic panels have been installed and the cables have been laid in place

Physical installation 2 - Inverter Grounding Installation

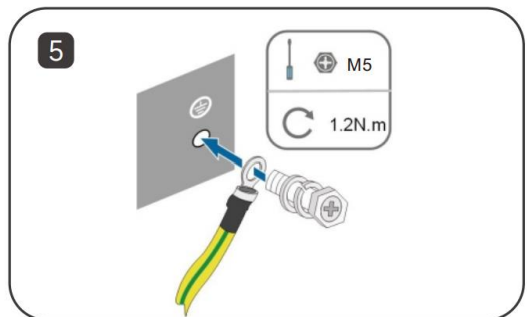
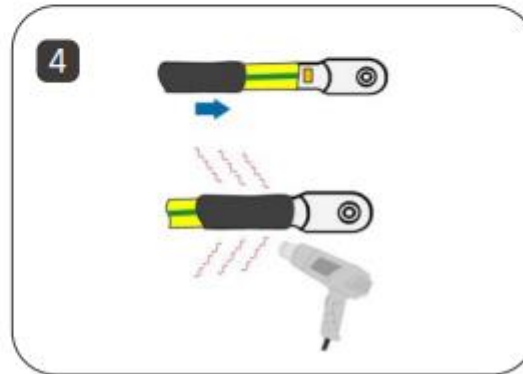
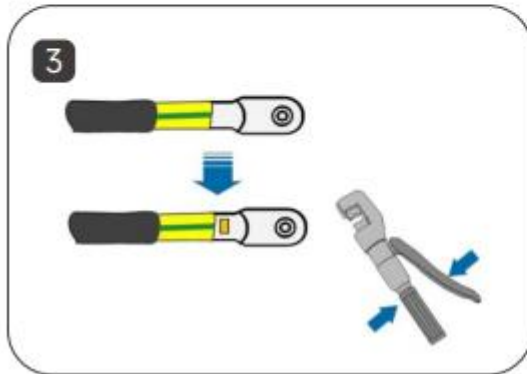
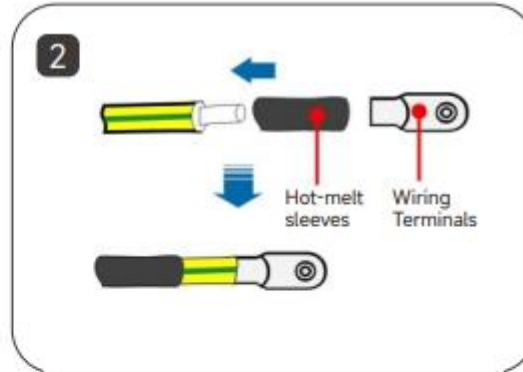
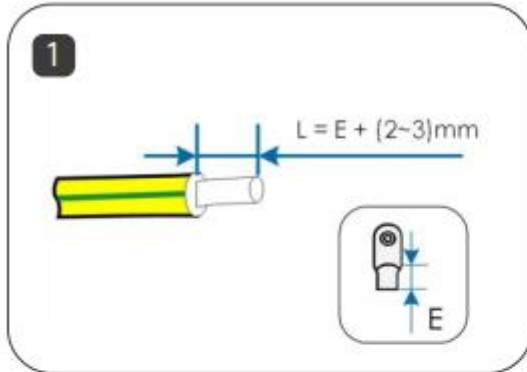

Step 1 : Strip off a certain length of insulation

$L = E + (2-3)mm$.

Step 2 : Pass the cable through the hot melt sleeve and insert it into the terminal block.

Step 3 : Use crimping pliers to tightly connect the terminal blocks and cables .

Step 4 : Adjust the hot melt sleeve to cover the end of the terminal block and the power cord, and use a hot air gun to blow the hot melt sleeve to cover the end of the power cord and terminal block.

Step 5 : Use a screwdriver to fix the ground wire to the inverter ground position.

Installation video(2m42s-3m19s):

https://webfile.hyxipower.com/soft/20240116/Installation-Video_String-Inverter_Ver1.0-202311.mp4

Physical Installation 3 - PV Side Connection

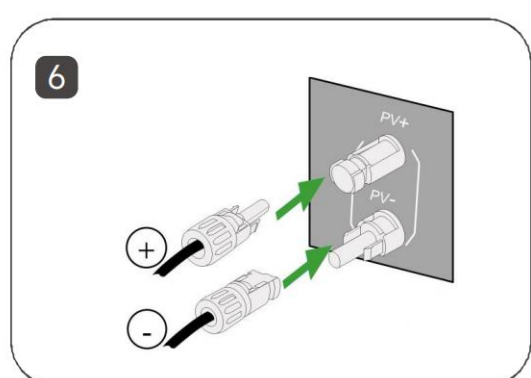
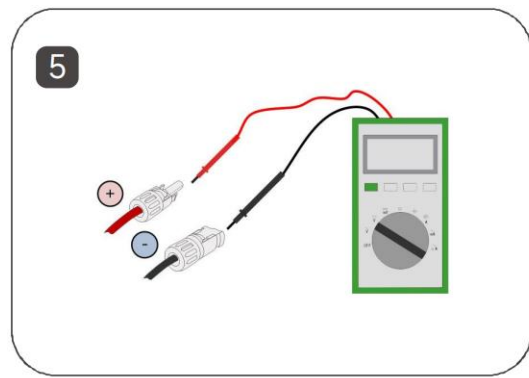
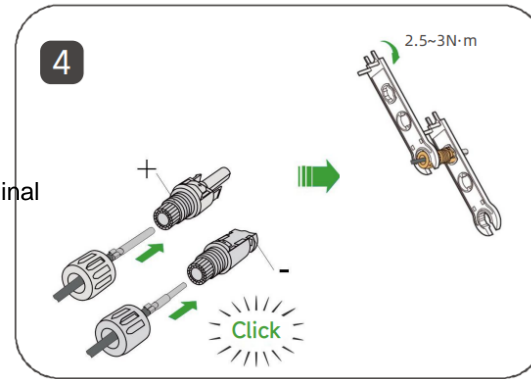
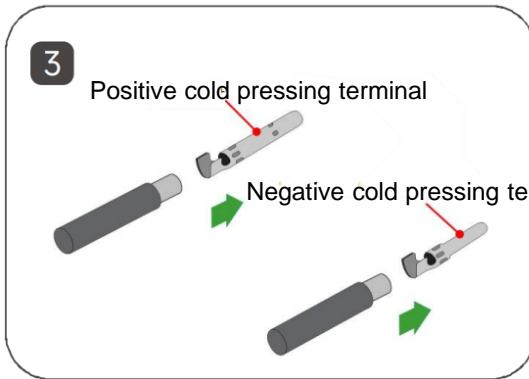
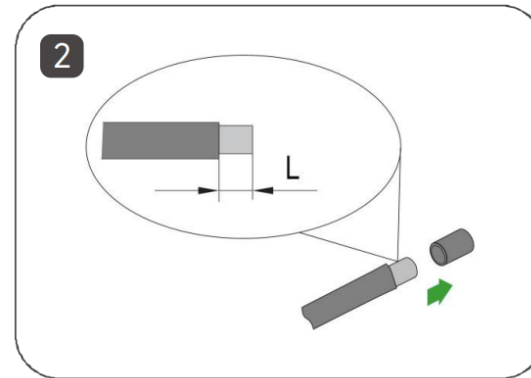
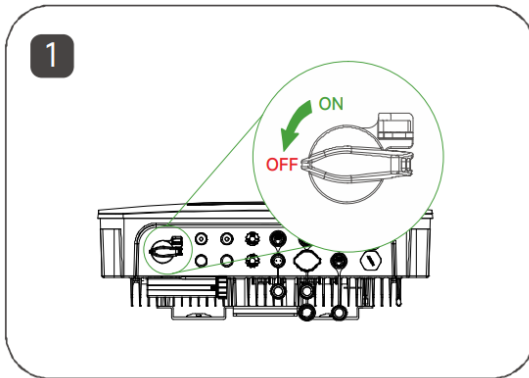

Step 1: Keep the switch on the inverter turned off.

Step 2: Strip all DC cables insulation by approximately 7 mm.

Step 3: Use crimping pliers to bundle the cold-pressed terminals to the cables. **Note that the positive and negative terminals are different** and need to be distinguished.

Step 4: Insert the cable through the cable sealing sleeve, insert it into the insulating sleeve and fasten it, and pull the cable gently to make sure it is tightly connected. Use 2.5 ~ 3N·m force to tighten the sealing sleeve and insulation sleeve.

Step 5: Use a multimeter to check whether the polarity of the photovoltaic string connecting cable is correct.

Step 6: Connect the PV connector to the corresponding terminal on the inverter until you hear a "click" sound.

Installation Video(3m22s-4m27s):

https://webfile.hyxipower.com/soft/20240116/Installation-Video_String-Inverter_Ver1.0-202311.mp4

Physical Installation 4 - AC Side(ON-Grid and Back Up)

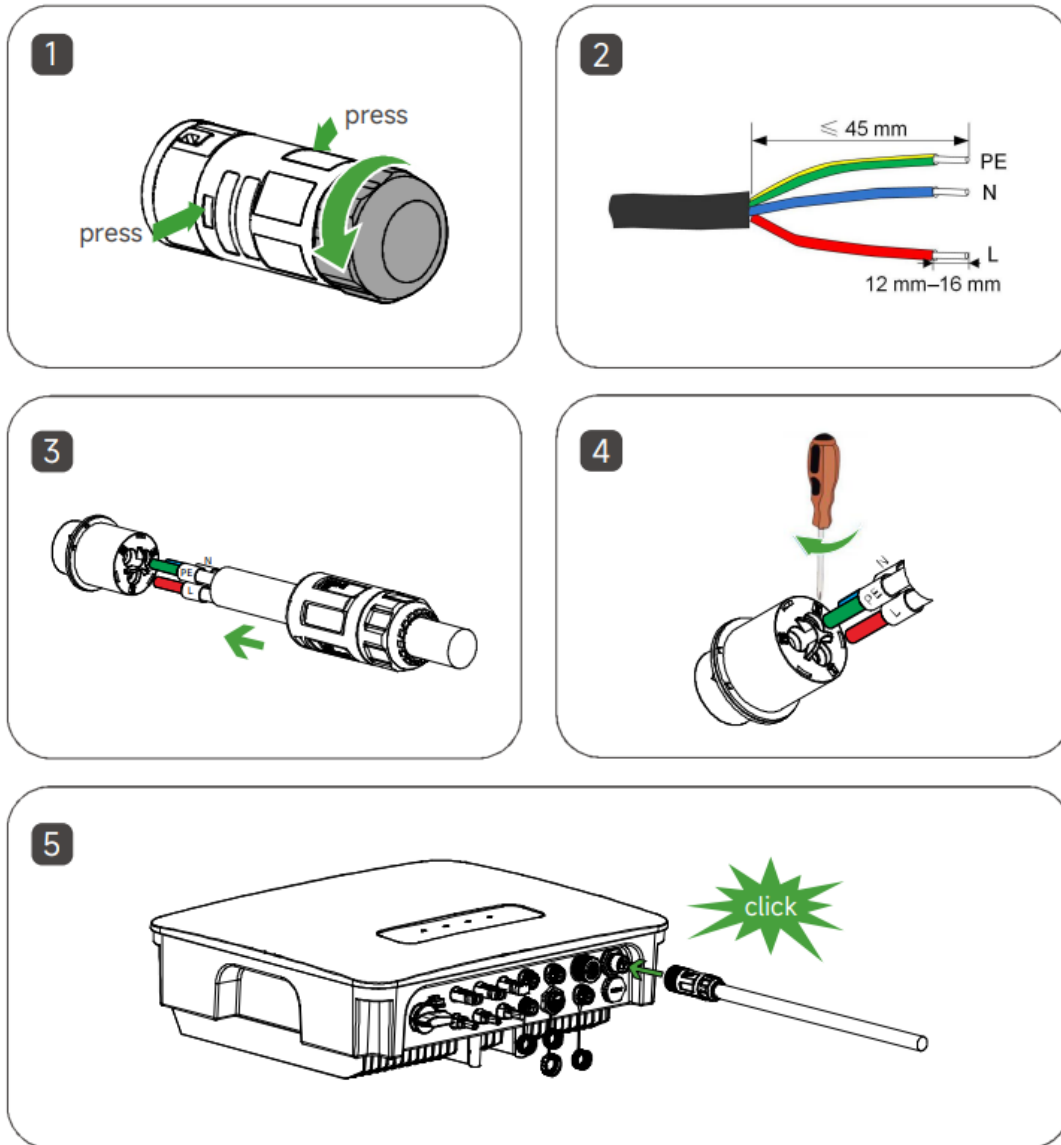

Step 1: Disassembling connector.

Step 2: Strip off a certain length of the protective layer and insulation as shown in the diagram.

Step 3: Adjust the 3 hexagonal screws loosely, do not unscrew the screws completely. Insert the 3 cores(of step 2) into the corresponding screw holes.

Step 4: Lock all 3 cores(of step 2) with 3 hexagonal screws.

Step 5: Assembling connector. Connect the AC connector to the appropriate terminal until a click is heard.

Note: ON-Grid side is a female connector and Back-Up side is a male connector.

Installation Video(4m28s-5m40s):

https://webfile.hyxipower.com/soft/20240116/Installation-Video_String-Inverter_Ver1.0-202311.mp4

Physical installation 5 - Meter Connection

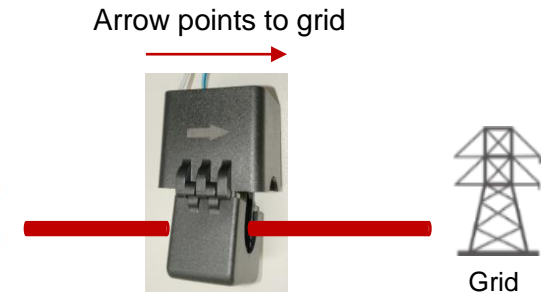
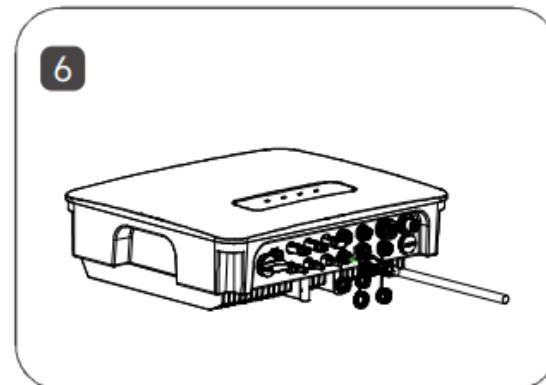
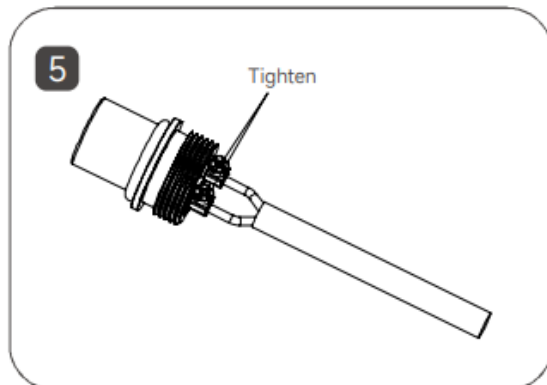
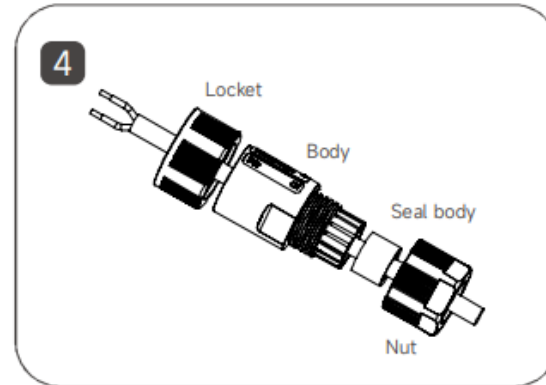
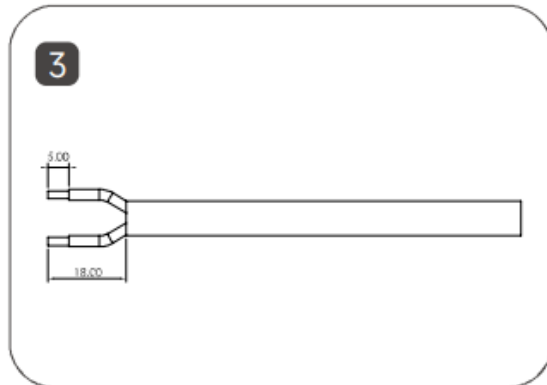
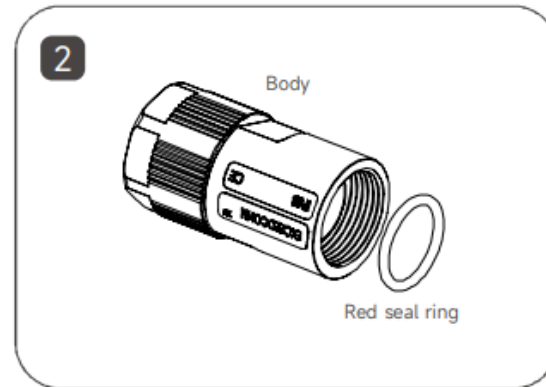
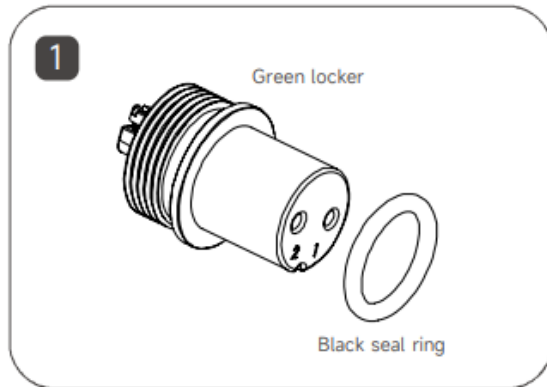

Figure 7

Figure 8

- Step 1:** Place black seal ring on the green Locker.
- Step 2:** Put red seal ring into the bottle of body inside.
- Step 3:** Wire stripping.
- Step 4:** Pass all parts through the wire in the following order.
- Step 5:** Crimp the 2pin copper core on the green locker and tighten it. **1 on the connector corresponds to A on the electric meter , and 2 corresponds to B on the electric meter** (Figure 7).
- Step 6:** Screw all parts together and connect the water-proof 2pin connector to inverter meter port.
- Step 7:** Connect the meter in parallel to the power grid, connect 3 to the live wire and 4 to the neutral wire.
- Step 8:** Pass the magnetic ring of the current transformer through the live wire of the grid. Note that the arrow points to grid (Figure 8).

Installation Video(6m54s-8m02s):
https://webfile.hyxipower.com/soft/20240116/Installation-Video_String-Inverter_Ver1.0-202311.mp4

Physical installation 6 - DCS communication stick installation

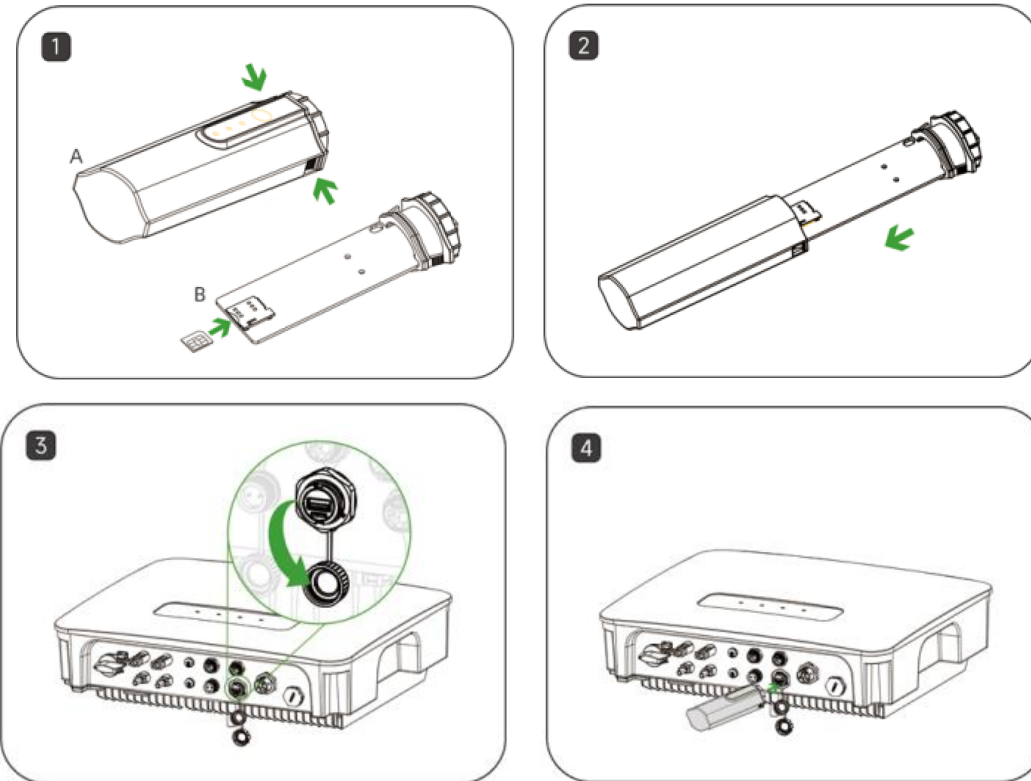

1. DCS communication stick installation (4G version)

Step 1: Remove the DCS protective cover and insert the SIM card;

Step 2: Install DCS waterproof cover;

Step 3: Remove the waterproof cover at the inverter communication interface;

Step 4: Insert the DCS into the corresponding communication terminal at the bottom of the inverter and tighten to ensure firmness.

2. DCS communication stick installation (Wi-Fi version does not require disassembly and installation of the sim card)

Step 1: Remove the waterproof cover at the inverter communication interface.

Step 2: Insert the DCS into the corresponding communication terminal at the bottom of the inverter and tighten it to ensure it is secure.

Note: For the Wi-Fi version, if the on-site Wi-Fi signal is poor (below -60dBm), you need to consider adding a Wi-Fi repeater to strengthen the network signal, otherwise there will be a risk that device data cannot be uploaded to the platform.

Installation video (5m45s-6m46s):

https://webfile.hyxipower.com/soft/20240116/Installation-Video_String-Inverter_Ver1.0-202311.mp4

Physical Installation 9- Inverter System Startup

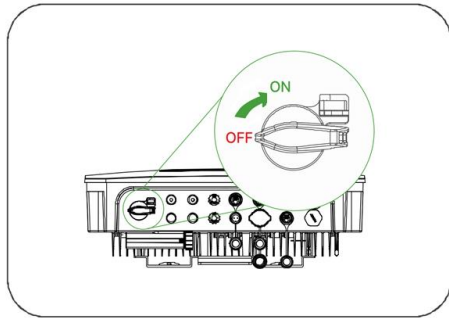

Figure 1

Step 1: Open the circuit breaker on the AC side.

Step 2: Open the circuit breaker on the photovoltaic side.

Step 3: Turn on the DC switch on the inverter.

Step 4: Confirm the indicator light status of the inverter. The indicator light status in Figure 2 is normal.



figure 2

No.	Indicator	Status	Description
1	POWER	ON	Inverter Powered ON
		OFF	Inverter Powered OFF
2	GRID	ON	Grid Normal
		Blink 1	Grid Abnormal
		Blink 2	Grid Disconnected
3	COM.	ON	COM. Normal
		Blink 1	Meter COM. Fault
		Blink 2	COM. Fault With BMS
		OFF	Fault Both Meter&BMS
4	ALARM	OFF	Normal
		Blink 1	Inverter Internal Alarm
		Blink 2	Other Alarms

Contents

1

Preparation

2

Product introduction

3

Physical installation

4

APP configuration

APP configuration 1- configuration process

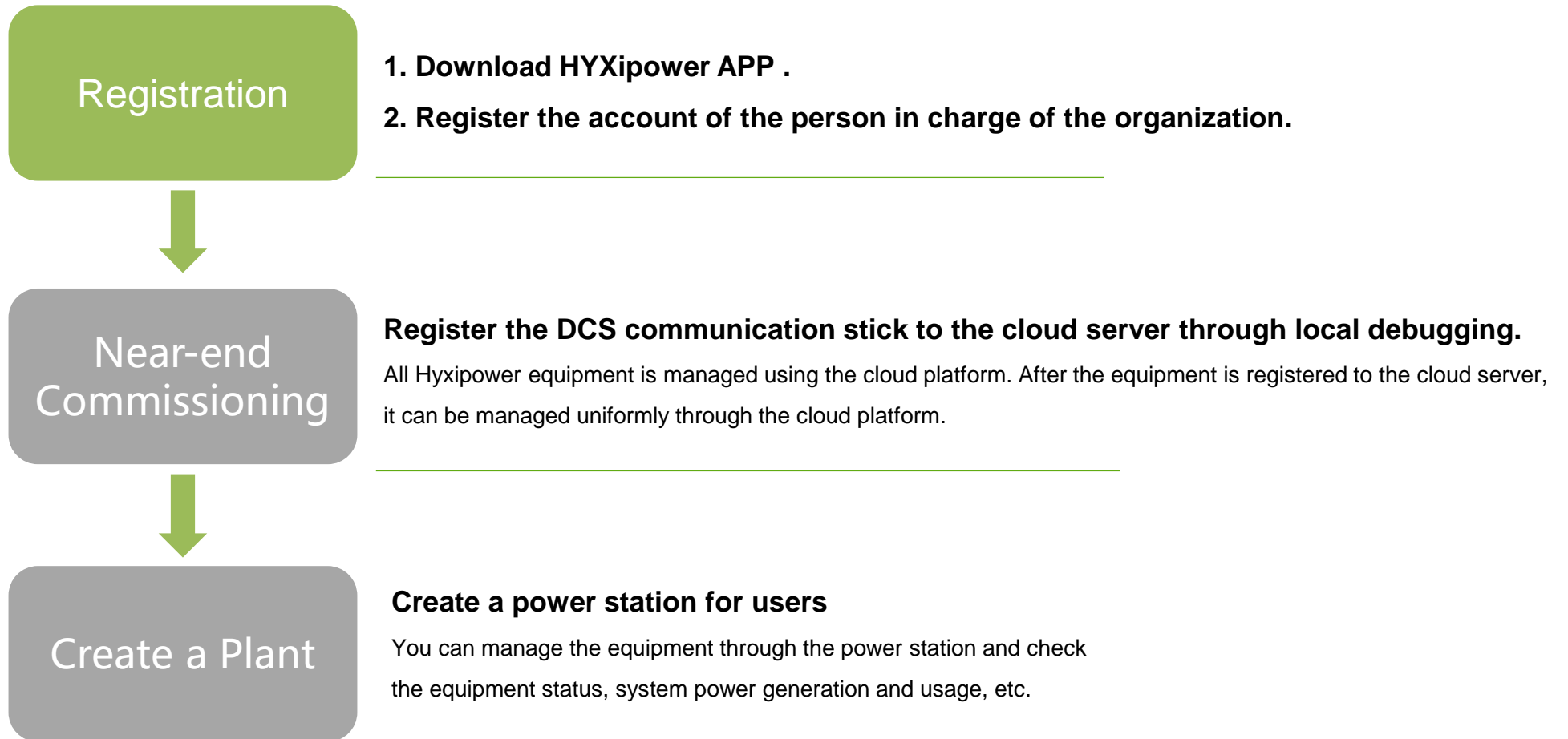

APP Configuration 1 - Download&Registration



The entire process requires 2 email accounts: Organization and Owner.

Step 1: Download the APP and **register** .

Step 2 : According to the country or region, select **server**, select **organization** , fill in the relevant information and **register**.

Method 1

Search "Hyxipower " in the App Store

- APP store (IOS)
- Google play

Method 2

Scan the QR code download the APP



APP Configuration 1 – Download&Registration - Admin registration



Step 3 : Log in to your account , select **Service - Member Management** , and then select " + " Invite members . It is recommended to choose **the administrator** role.

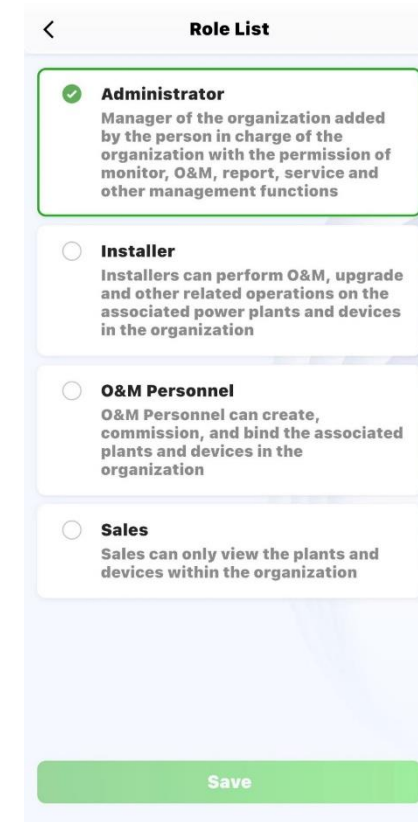
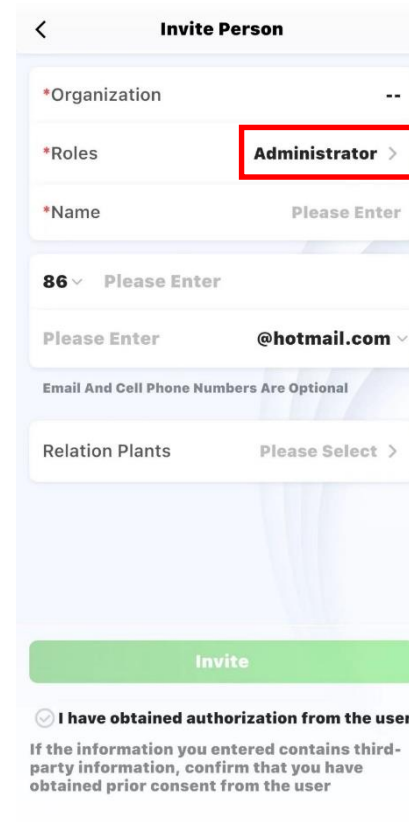
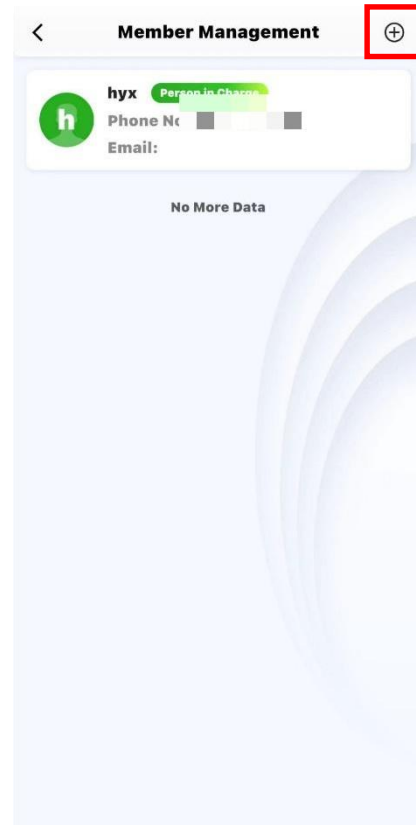
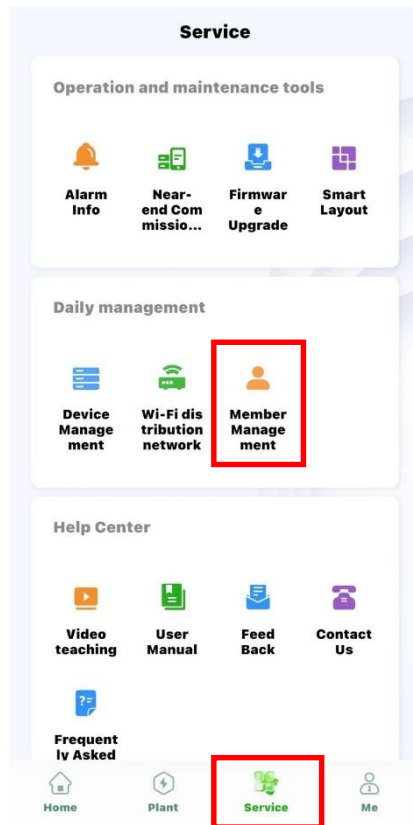

APP configuration 1- configuration process



Registration

1. Download HYXipower APP .
2. Register the account of the person in charge of the organization.

Near-end
Commissioning

Register the DCS communication stick to the cloud server through local debugging.
All Hyxipower equipment is managed using the cloud platform. After the equipment is registered to the cloud server, it can be managed uniformly through the cloud platform.

Create a Plant

Create a power station for users
You can manage the equipment through the Plant and check the equipment status, system power generation and usage, etc.

APP configuration 2- Near-end Commissioning



Step 1: Open the APP. Please **update APP** before debugging if there is one. Select **More** and choose your local server. Then choose **Near-end Commissioning**. It will take few seconds **download the latest firmware**. The file will be stored in the phone as a backup. If the phone has the latest firmware package, this step will be skipped.

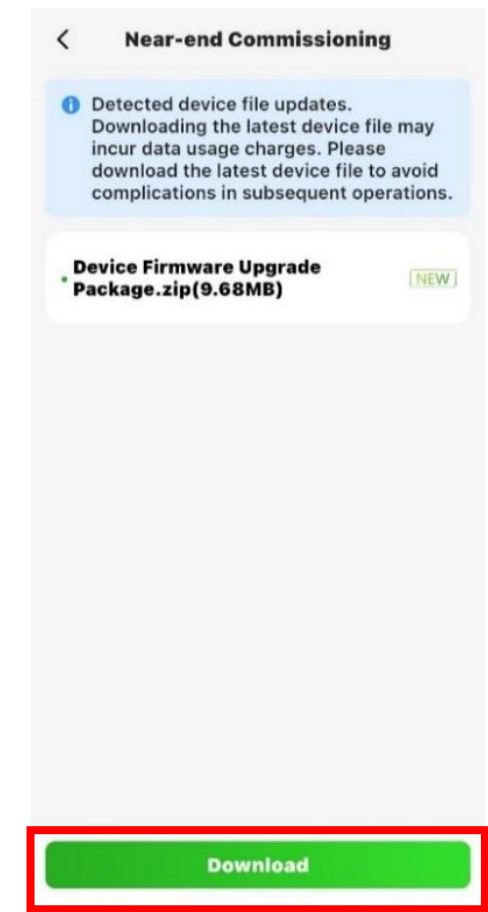
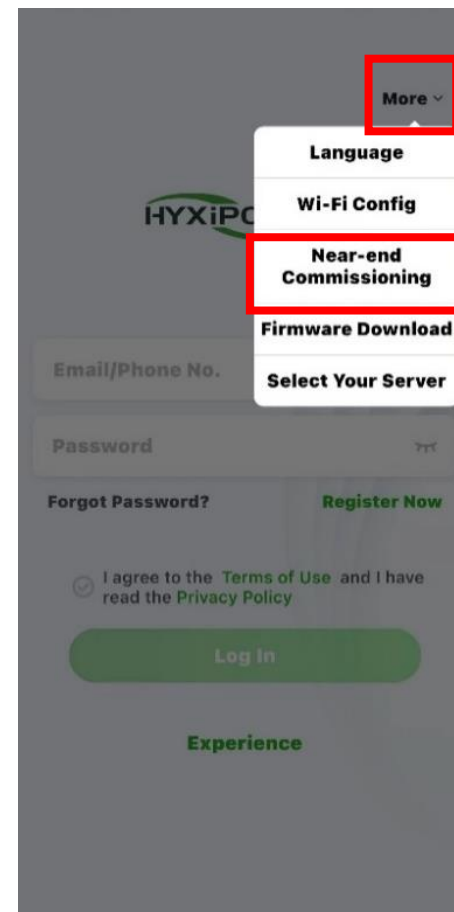
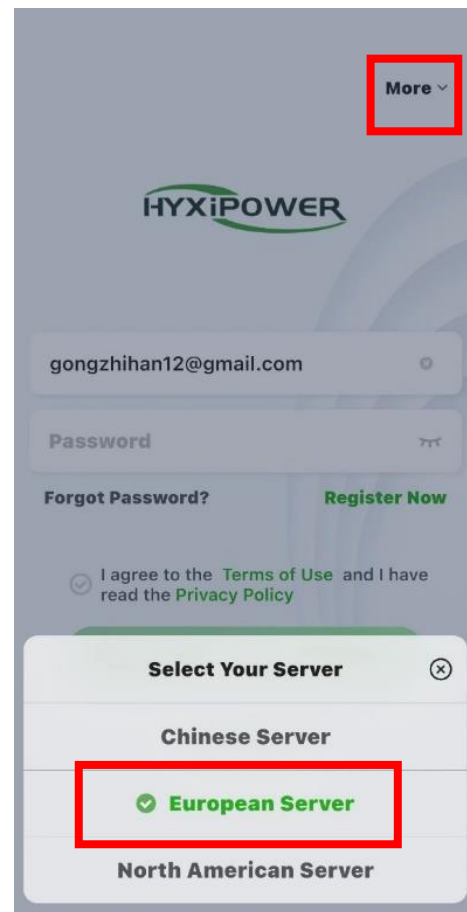
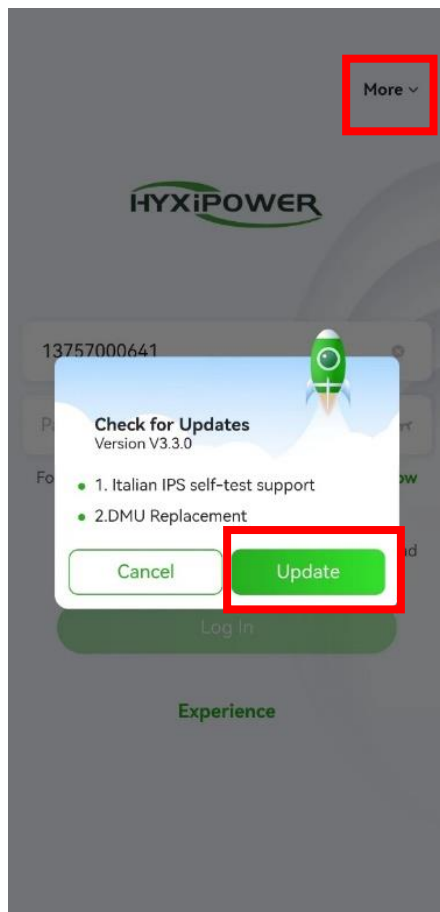

APP configuration 2 - Near-end Commissioning



Step 2 : Scan DCS QR code ,
Join wireless network DCS-XXXXXXXXXXXX .

If the scanned barcode cannot be recognized,
You can also choose **to connect manually** .

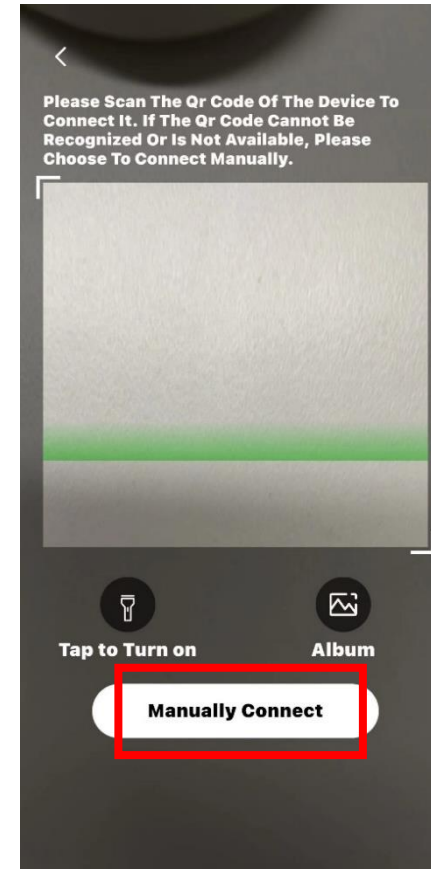
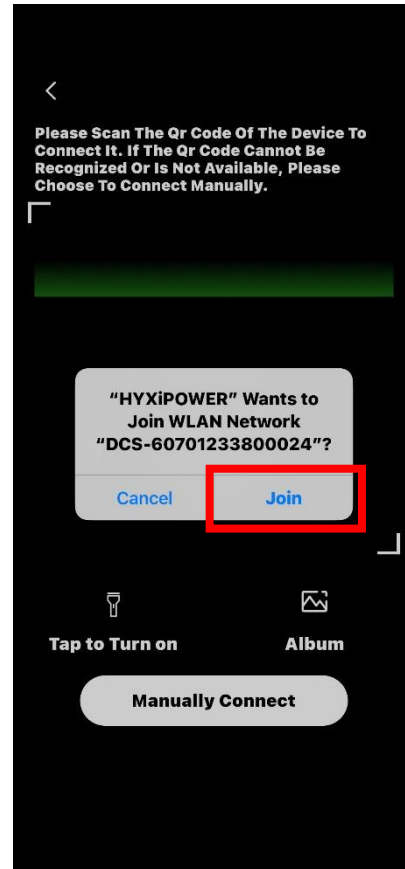
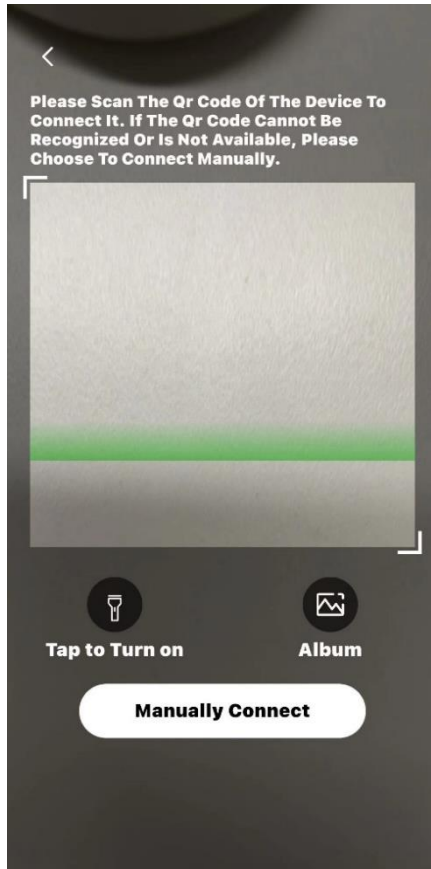

APP configuration 2 - Near-end Commissioning



IOS

Find the WIFI in settings of phone starting with DCS and connect: DCS-XXXXXXXXXXXX, Password is **hyxi0607** or **12345678**, after connected, **return** to the "Hyxipower" APP and select **Next**.

APP

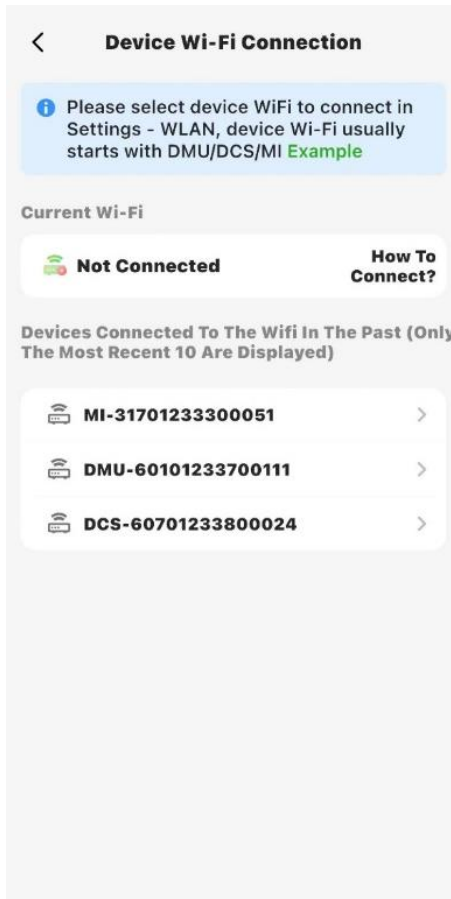

Keep the APP running in the background and enter the WiFi settings page **manually**.

Enter the WiFi password.

Then return to the APP.

WIFI setting interface

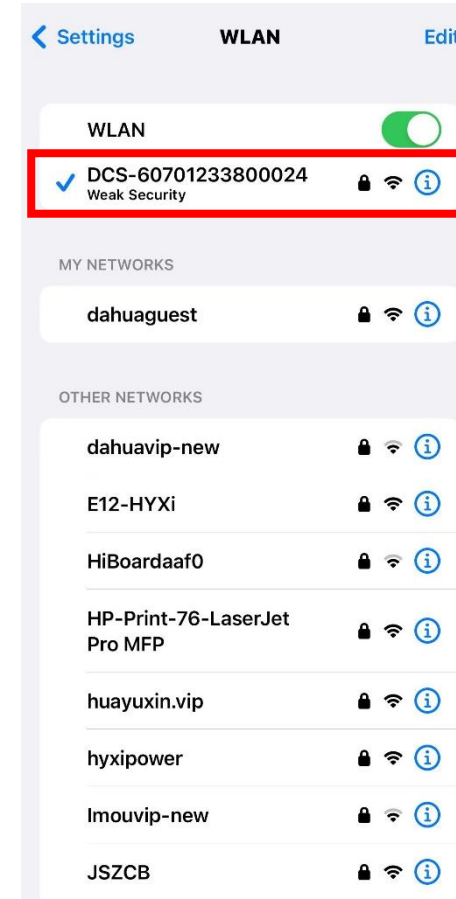
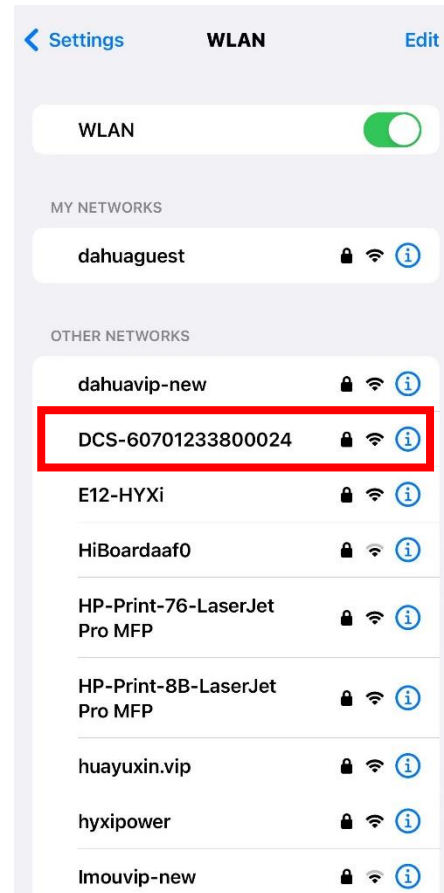

APP



APP configuration 2 - Near-end Commissioning



Android system :

Find the WIFI in settings of phone starting with DCS and connect: DCS-XXXXXXXXXXXXX;
Password is **hyxi0607** or **12345678**, after connected, **return** to the "Hyxipower" APP and select **Next**.

APP



Keep the APP running in the background and enter the WiFi settings page **manually**.

Enter the WiFi password.

Then return to the APP.

WIFI setting interface

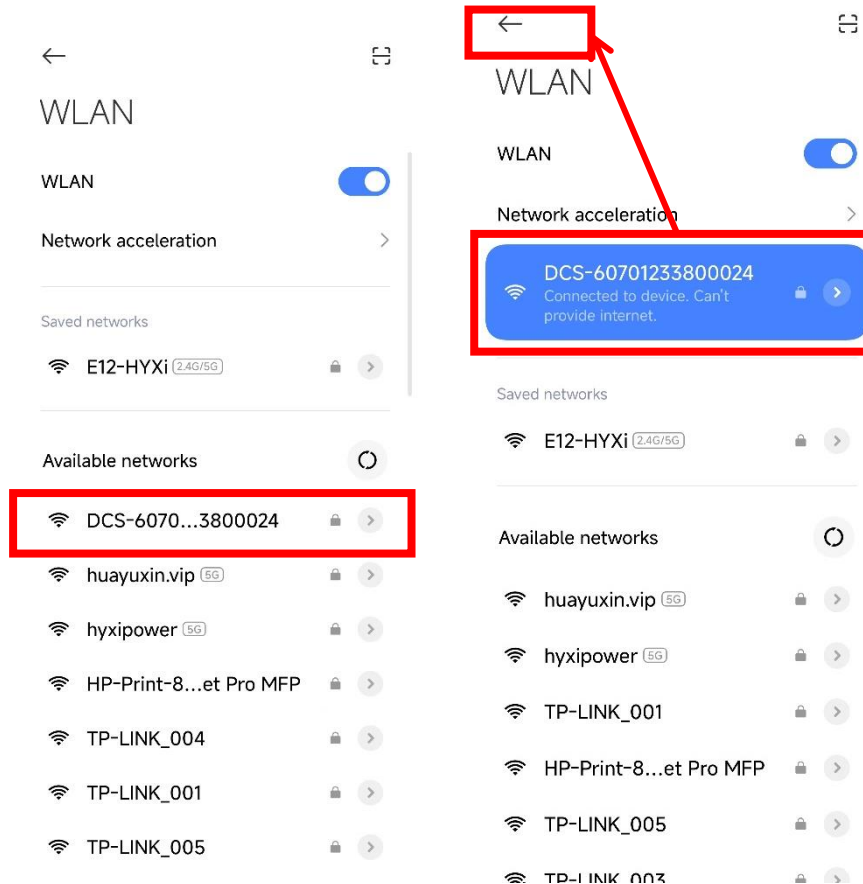

APP

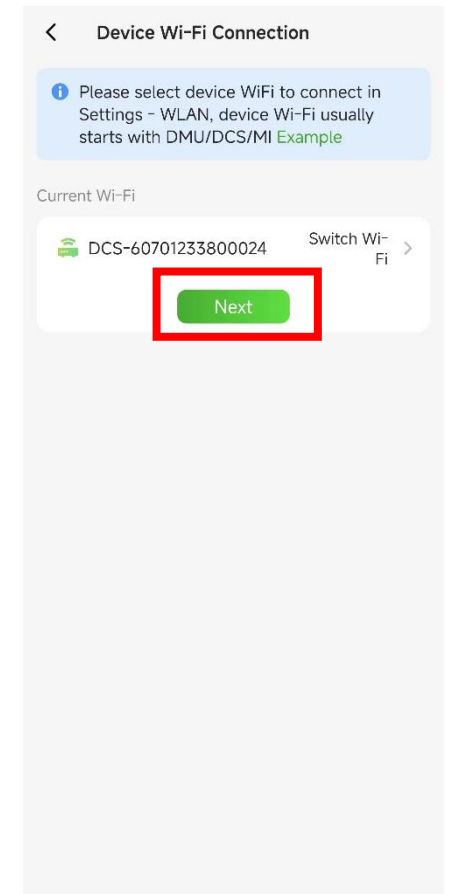

APP Configuration 2 - Near-end Commissioning

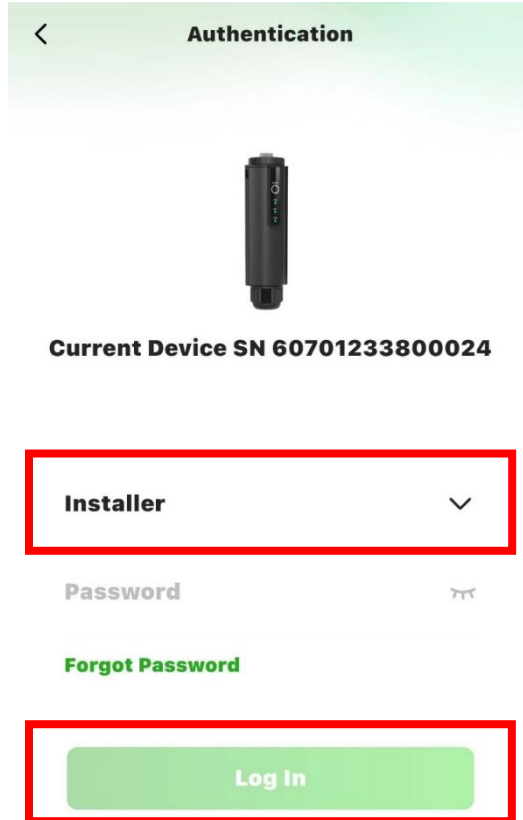

Step 3 : Device login, initial password: hyxi0607. (If the password is incorrect, please try 12345678) Log in and change the password, then save. (Record the new password. If you forget the password, you can quickly press the DCS RESET button 4 times to restore the factory settings)

APP Configuration 2 - Near-end Commissioning



Step 4 : Quick Settings - Device Management , Click the meter to configure the meter (if there is no meter configuration option, please contact Hytxipower service for DCS upgrade)

The meter configuration is filled in as follows by default: Number of meters: 1; Address: 1; Installation location: Grid side.

The screenshots illustrate the following steps:

- Home Screen:** The 'Quick settings' icon is highlighted with a red box.
- Quick settings:** The 'Meter' option is highlighted with a red box. Below it, the 'Configuration Of Meters' option is also highlighted with a red box.
- Configuration Of Meters (Step 1):** The screen prompts the user to select the total number of meters and enter their addresses. The 'Number Of Meters' is set to 1, and the 'Address' is set to 1. These fields are highlighted with a red box.
- Configuration Of Meters (Step 2):** The screen shows a schematic diagram of a meter connected to a grid. The text reads: 'Please Refer To The Schematic Connection No.1 Meter (Note The Wiring Direction Of The Ct Ring)'.
- Configuration Of Meters (Step 3):** The screen prompts the user to select the mounting position. 'Grid-Side' is selected and highlighted with a red box. Below, the 'Current Meter Address' is set to 1, which is also highlighted with a red box. A note states: 'The Meter Address Will Be Automatically Assigned To The 1'. A 'Modify Original Address' link is visible.

At the bottom of each screenshot, there is a green button: 'Next', 'Start Configuring Meters One By One', 'Connected, Starting Configuration No.1 Meter', and 'Meter Configuration Completed'.

APP Configuration 2 - Near-end Commissioning



Step 5 : Grid connection settings, select your **time zone** and **Grid Code**.

Click **Next**, please follow the prompts to upgrade first if there is one.

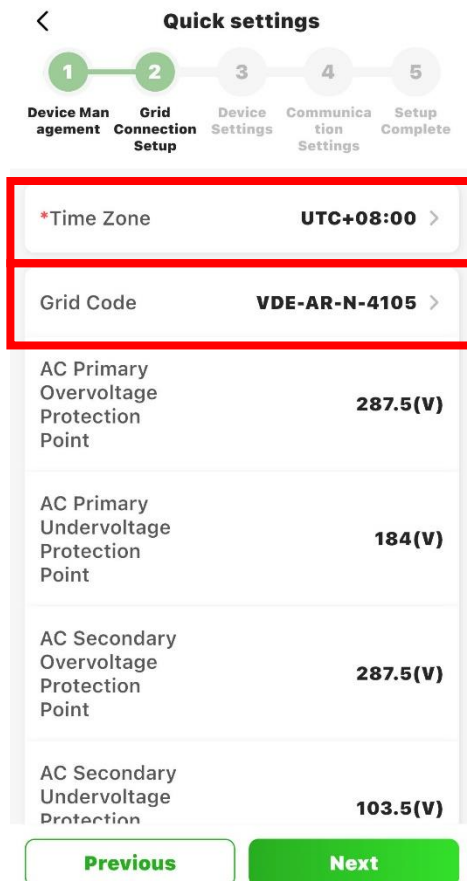

Step 6 : Device settings - feeder power limit setting - **If there is a need to inject into the grid, set the corresponding power value.**

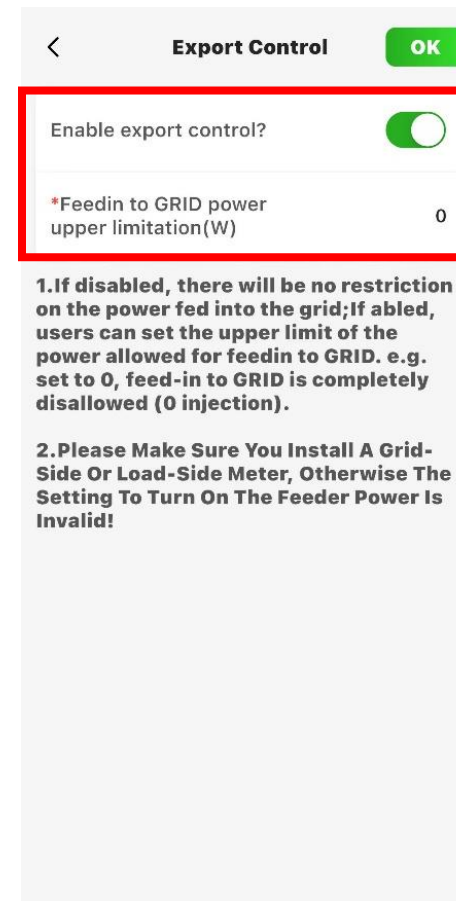
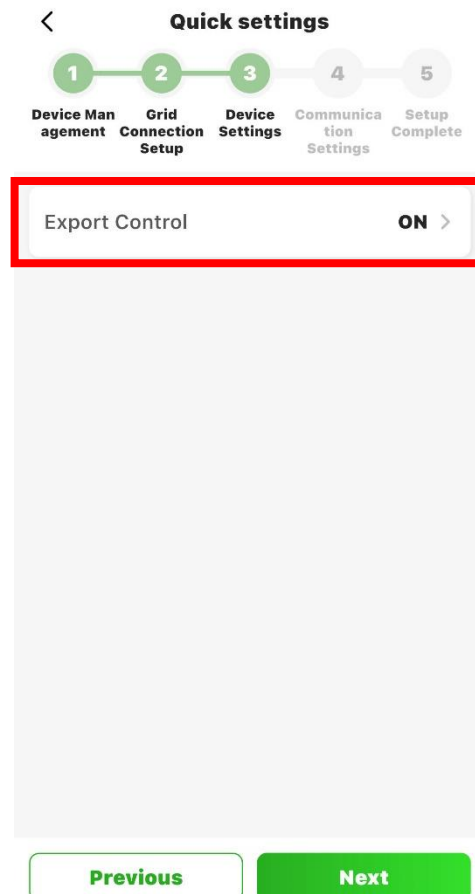

APP Configuration 2 - Near-end Commissioning



Step 7 : Communication settings, Choose your local **server**, fill in the **Wi-Fi name and password** for wireless mode. Confirm the automatic IP acquisition switch is **ON** for **wired connection mode**. No need to fill in the **APN, username and password** for the **4G version wireless mode**. The next step is to wait for the device to connect to the Internet.

Android users can automatically obtain the corresponding wifi name

IOS users need to manually input the WiFi name

The image displays four sequential screenshots of the 'Quick settings' screen in the app, illustrating the configuration process for communication settings. Each screen shows a progress indicator at the top with five steps: 1. Device Management, 2. Grid Connection Setup, 3. Device Settings, 4. Communication Settings, and 5. Setup Complete. The current step is highlighted in green.

- Screen 1:** Shows the 'Communication Settings' step. It includes a progress indicator, a 'Connection Domain' section with a red box around '*Cloud Platform Address' and 'European Server', and a 'Cloud platform server communication mode' section with a red box around '*COMM. Mode' and 'Wireless Connection Mode'. Below this is a 'Wireless connection mode parameter configuration' section with a red box around '*Wi-Fi Name' and 'WiFi', and a 'Wired connection mode parameter configuration' section with a red box around the 'Automatic IP Acquisition Switch' toggle, which is currently turned on and labeled 'wired' in red.
- Screen 2:** Shows the 'Communication Settings' step. It includes a progress indicator, a 'Connection Domain' section with a red box around '*Cloud Platform Address' and 'European Server', and a 'Cloud platform server communication mode' section with a red box around '*COMM. Mode' and 'Wired Connection Mode'. Below this is a 'Wired connection mode parameter configuration' section with a red box around the 'Automatic IP Acquisition Switch' toggle, which is currently turned on and labeled 'wired' in red.
- Screen 3:** Shows the 'Communication Settings' step. It includes a progress indicator, a 'Connection Domain' section with a red box around '*Cloud Platform Address' and 'European Server', and a 'Cloud platform server communication mode' section with a red box around '*COMM. Mode' and 'Wireless Connection Mode'. Below this is a 'Wireless connection mode parameter configuration' section with a red box around '*COMM. Mode' and 'Wireless Connection Mode'. Below this is a 'Wired connection mode parameter configuration' section with a red box around the 'Automatic IP Acquisition Switch' toggle, which is currently turned on and labeled 'wired' in red.
- Screen 4:** Shows the 'Setup Complete' step. It includes a progress indicator, a 'Connection Domain' section with a red box around '*Cloud Platform Address' and 'European Server', and a 'Cloud platform server communication mode' section with a red box around '*COMM. Mode' and 'Wireless Connection Mode'. Below this is a 'Wireless connection mode parameter configuration' section with a red box around '*COMM. Mode' and 'Wireless Connection Mode'. Below this is a 'Wired connection mode parameter configuration' section with a red box around the 'Automatic IP Acquisition Switch' toggle, which is currently turned on and labeled 'wired' in red.

Each screen also features a 'Previous' button and a 'Next' button at the bottom.

APP Configuration 2 - DCS status confirmation

Step 8 : After Near-end Commissioning completed, you need to check the status of the DCS indicator. If it is as shown in the figure below, the network connection is successful. If the indicator light displays abnormally, please refer to " Preparation 6-DCS Communication Stick Introduction " to check the cause of the abnormality.



APP Configuration 3 - Create a Plant



Registration

1. Download HYXipower APP .
2. Register the account of the person in charge of the organization.



Near-end Commissioning

Register the DCS communication stick to the cloud server through local debugging.
All Hyxipower equipment is managed using the cloud platform. After the equipment is registered to the cloud server, it can be managed uniformly through the cloud platform.



Create a Plant

Create a power station for users

You can manage the equipment through the Plant and check the equipment status, system power generation and usage, etc.

APP Configuration 3 - Create a Plant

Step 1: Disconnect the phone from the DCS's WiFi. Make sure your phone has Internet access

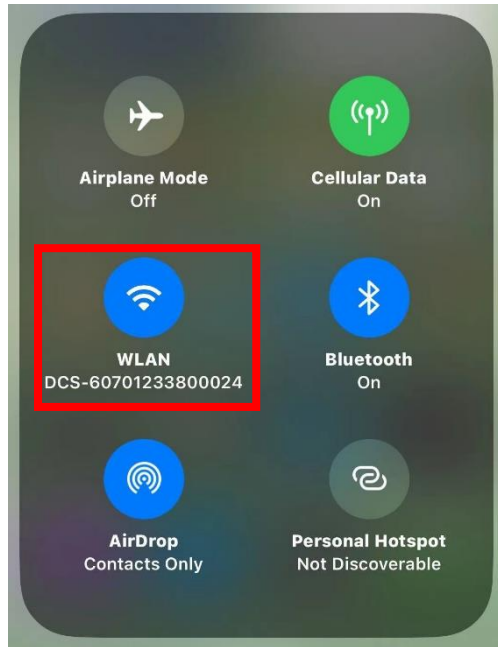

Step 2: Log in to your organization account, click the **Add Plant button**

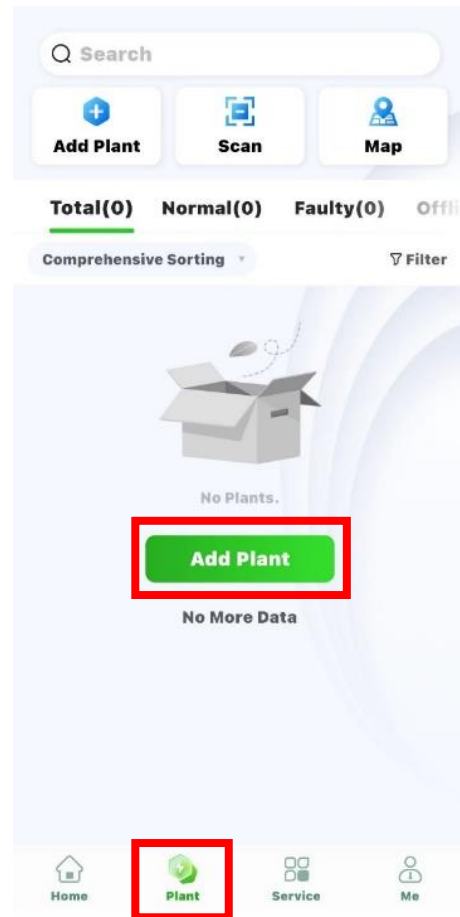

Step 3: Scan the QR code of the DCS or add it through the Recently debugging device

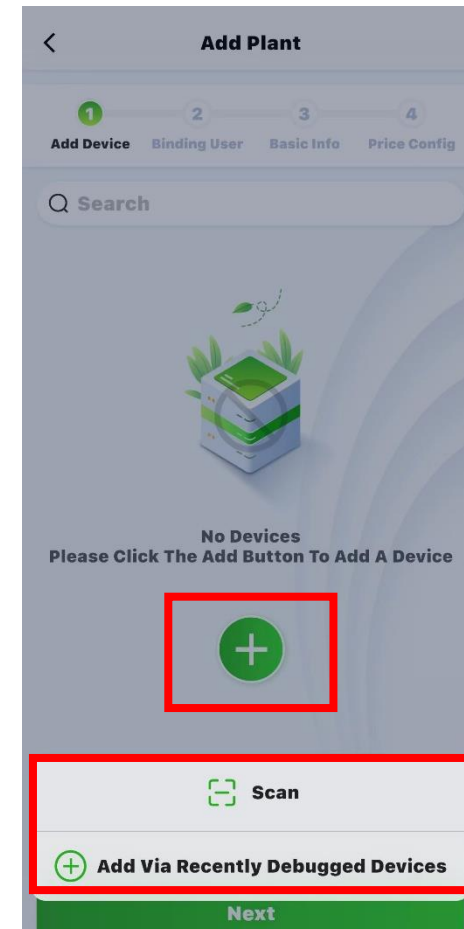

APP Configuration 3 - Create a Plant

Step 4: Add owner - manually add or scan the owner's QR code to bind. Manually add - enter the email address or mobile phone number of the Plant owner. If the owner is not registered, click to help him register and bind. The system will generate a random password and send a text message or email to the registered account

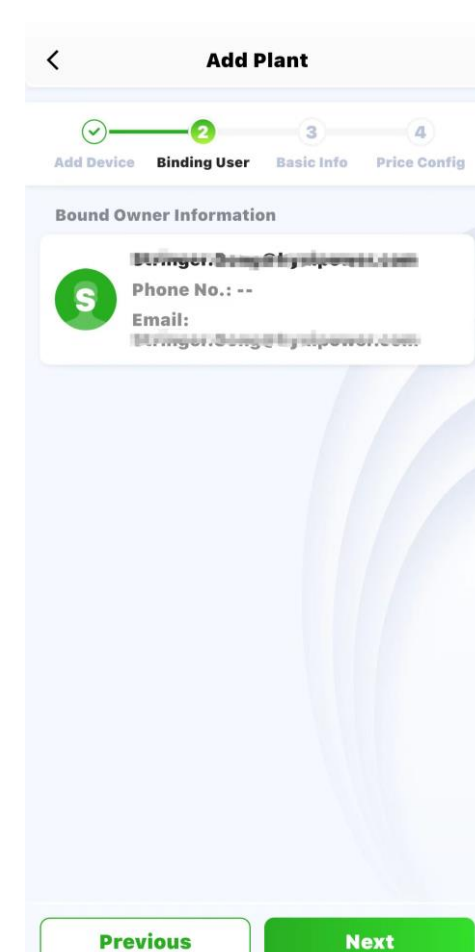
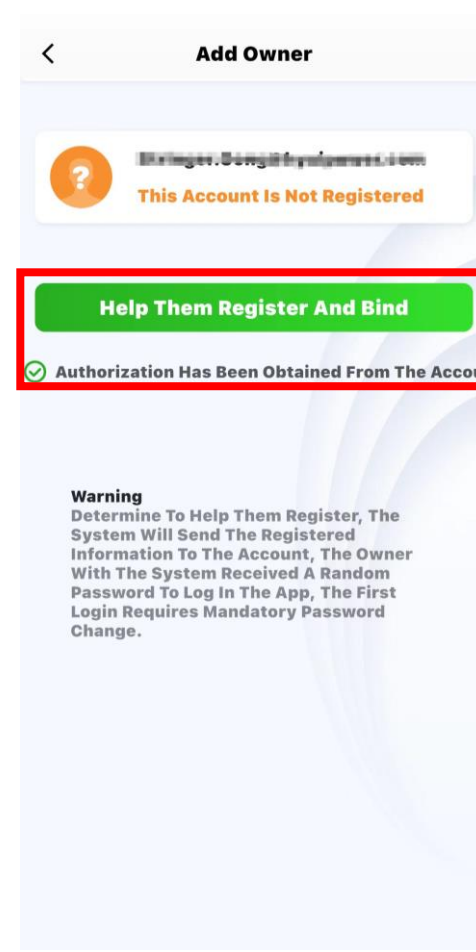
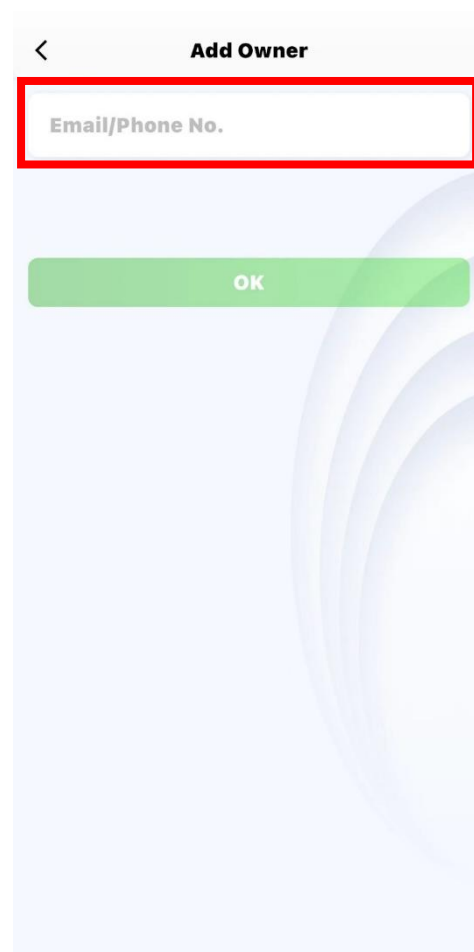
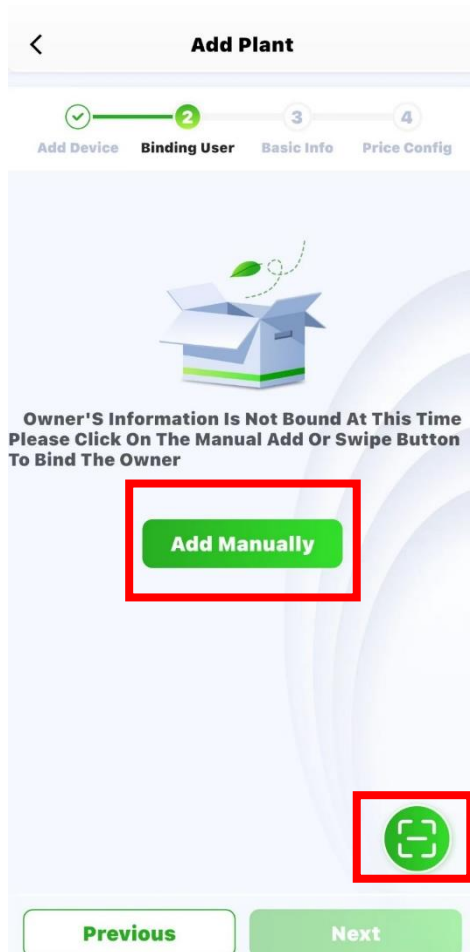

APP Configuration 3 - Create a Plant



Step 5: Plant name-Plant type(House hold Use)-
Region-Time Zone

Step 6: More Info-Next.

Add Plant

Progress: 1. Add Device, 2. Binding User, 3. Basic Info, 4. Price Config

*Plant Name: recoderag@163.com20 24-04-10

*Plant Type: Household Use >

Region: 中国浙江省杭州市滨江区

Plant Address: 浙江省杭州市滨江区长河街道滨兴路1399号-大华股份(总部)

*Time Zone: (UTC+08:00) Beijing, Chongqing, Hong Kong, Urumqi >

More Info

Previous Next

Plant Type

Please select the correct power station type

- Household Use**
For small and medium-sized projects, typically under 100 kW, dominated by microinverters, residential energy storage, and string systems
- Industry and Commerce**
For large-scale commercial and industrial projects, typically under 100 kW, dominated by high-capacity household energy storage and high-capacity string systems
- Energy Storage**
For projects dominated by commercial and industrial energy storage cabinets, typically over 100 kW

Add Plant

Progress: 1. Add Device, 2. Binding User, 3. Basic Info, 4. Price Config

*Plant Name: recoderag@163.com20 24-04-10

*Plant Type: Household Use >

Region: 中国浙江省杭州市滨江区

Plant Address: 浙江省杭州市滨江区长河街道滨兴路1399号-大华股份(总部)

*Time Zone: (UTC+08:00) Beijing, Chongqing, Hong Kong, Urumqi >

More Info

Previous Next

Add Plant

Progress: 1. Add Device, 2. Binding User, 3. Basic Info, 4. Price Config

Photovoltaic installed capacity: Please Enter kWp

Number of Strings: Please Enter

Grid Connection Type: Feed All to Grid >

Contribution Type: Full Payment by Owner >

Contact Phone No: Please Enter

Remarks: Please Enter

Plant Image: Upload

Show Less

Previous Next

APP Configuration 3 - Create a Plant

Step 6: Fill in Electricity Price Type, Currency and Revenue per kWh, select Finish, and the Plant is successfully created.

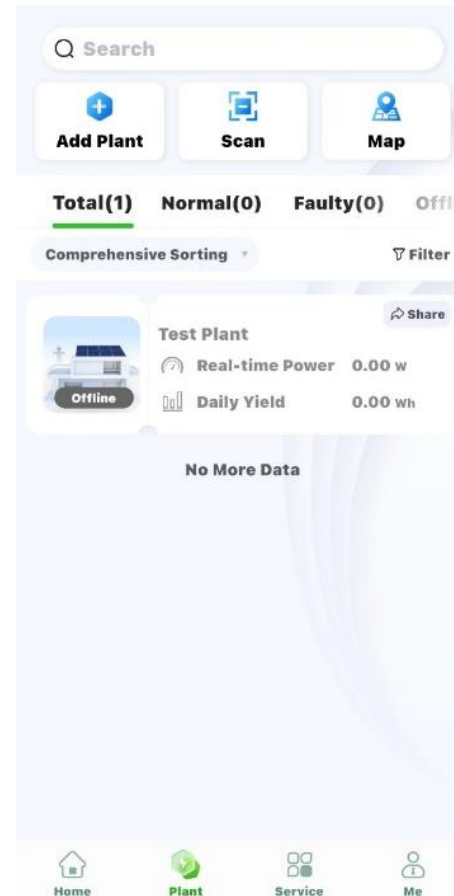
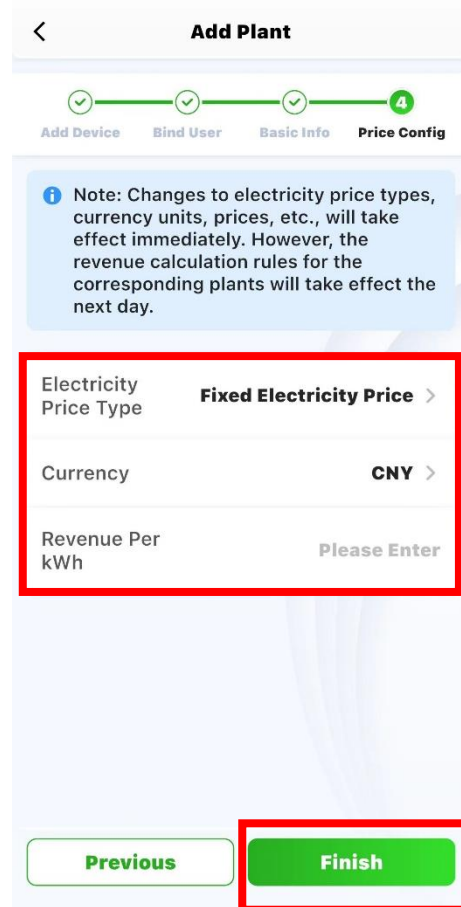

Installation Acceptance



Step 1: Select **Plant - User's Plant - Device**, and ensure that the online state of device is correct.

Step 2: After installation is completed, continuously monitor for more than half an hour, select **Statistics - Energy Analysis**, view the realtime power statistics curve, and ensure that the Plant has started generating electricity normally.

After confirming that all the above are normal, it indicates that the device installation and configuration is successful!



THANKS

Zhejiang Hyxi Technology Co., Ltd.

Quality

Innovation

Efficiency

Win-win

